



TP WESTERN ODISHA DISTRIBUTION LIMITED
(A Tata Power & Odisha Govt. Joint venture)
Corporate Office, Burla-768017

Procedure to Participate in E-Tender

Tender Enquiry No- TPWODL/NP/O/SU/024

Tender Enquiry No	Work Description	EMD (₹)	Tender Participation Fee (₹)	Last Date and Time for payment of Tender Participation Fee
TPWODL/NP/O/SU/024	Rate Contract for Supply of Hardware Fittings as per the schedule. (Annexure – I enclosed)	0.50 Lakh	5900 (Incl. GST)	23 th June' 2023, 15.00 Hrs.

Please note that corresponding details mentioned in this document will supersede any other details mentioned anywhere else in the Tender Document.

Procedure to Participate in Tender.

Following steps to be done before “Last date and time for Payment of Tender Participation Fee” as mentioned above

1.

- a. **For Regular Bidders-** Non-Refundable Tender Participation Fee, as indicated in table above, to be submitted in the form of direct deposit in the following bank account and submit the receipt along with a covering letter clearly indicating the Tender Reference number –

Beneficiary Name : TPWODL Expenditure Account
Bank Name : Union Bank of India
Branch Name : Sambalpur Naya Para
Address : At/P.O.- Sambalpur, Dt: Sambalpur, Odisha-768 001
Branch Code : 536521
Account No. : 365201010033244
Account Type : Current
IFSC Code : UBIN0536521

- b. **For Local MSME Category Bidders-** Local MSME Registered in the State of Odisha refer to Annexure-XI (**Norms for procurement from MSMEs registered in the state of Odisha**) for details of tender participation.

Interested MSME bidders are required to submit undertaking with valid registration certificate before last date and time of tender purchase.

2. **Authorization letter-** Eligible and Interested Bidders to submit duly signed and stamped letter on Bidder's letterhead indicating

- a. Tender Enquiry number

- b. Name & Address of the Bidder
- c. Name of authorized person
- d. Contact number
- e. e-mail id
- f. Details of submission of Tender Participation Fee
- g. GST Registration No

E-mail with necessary attachment of 1 and 2 above shall be sent to nikhil.patel@tpwesternodisha.com with a copy to ajit.singh@tpwesternodisha.com before last date and time for payment of Tender Participation Fee.

Interested bidders to submit Tender Participation Fee and Authorization Letter before Last date and time as indicated above after which link from TPWODL E-Tender system (Ariba) will be shared for further communication and bid submission.

Please note all future correspondence regarding the tender, bid submission, bid submission date extension, Pre-bid query etc. will happen only through TPWODL E-Tender system (Ariba). User manual to guide the bidders to submit the bid through E-Tender system (Ariba) is also enclosed.

No e-mail or verbal correspondence will be responded. All communication will be done strictly with the bidders who have done the above step to participate in the Tender.

Also, it may be strictly noted that once date of “Last date and time for Payment of Tender Participation Fee” is lapsed no Bidder will be sent link from TPWODL E-Tender System (Ariba). Without this link BA will not be able to participate in the tender. Any last moment request to participate in tender will not be entertained.

Any payment of Tender Participation Fee by Bidder who have not done the prerequisite will not be refunded.

Also all future corrigendum's to the said tender will be informed on Tender section on website <https://www.tpwesternodisha.com>.

Tender Documents

CONFIDENTIAL



TP WESTERN ODISHA DISTRIBUTION LIMITED
(A Tata Power and Odisha Government Joint Venture)
Corporate Office: Burla – 768017 ,www.tpwesternodisha.com

NIT: TPWODL/NP/O/SU/024

OPEN TENDER NOTIFICATION

for

One Year Rate Contract for Supply of Hardware Fittings

Tender Enquiry No.: TPWODL/NP/O/SU/024

Due Date for Bid Submission: - 10-July-2023 [15:00 Hrs.]

TP Western Odisha Distribution Limited (TPWODL)
Burla, Sambalpur - 768017

CONTENTS OF THE ENQUIRY**Contents**

1.0	Event Information	3
2.0	Evaluation Criteria	5
3.0	Submission of Bid Documents	5
4	Bid Opening & Evaluation process	8
5	Award Decision	9
6	Order of Preference/Contradiction	9
7	Post Award Contract Administration	9
8	Specification and standards	11
9	General Condition of Contract	11
ANNEXURE I	12
ANNEXURE II	13
ANNEXURE III	14
ANNEXURE IV	15
ANNEXURE V	16
ANNEXURE VI	17
ANNEXURE VII	18
ANNEXURE VIII	19
ANNEXURE IX	20
ANNEXURE X	21
ANNEXURE XI	22

1.0 Event Information**1.1. Scope of work**

Open Tenders are invited from interested Bidders entering into a Rate Contract valid for **1 year** for the following:

S. No.	Description	EMD Amount (Lacs)	Tender Fee (Rs.)
1.	Rate Contract for Supply of Hardware Fittings as per the schedule	0.50	5900 (Incl. GST)

1.2. Availability of Tender Documents**1.3. Calendar of Events**

(a)	Date of sale/ availability of tender documents from TPWODL Website	12.06.2023 10:00 Hours
(b)	Last date and time of Payment of Tender Fee	23.06.2023 15:00 Hours
(c)	Last Date of receipt of pre-bid queries, if any	27.06.2023 15:00 Hours
(d)	Last Date of Posting Consolidated replies to all the pre-bid queries as received	30.06.2023 15:00 Hours
(e)	Last date and time of receipt of Bids	10.07.2023 15:00 Hours
(g)	Date & Time of opening technical bids & EMD (Envelope-1 & 2)	Participating Bidders will get mail intimation from TPWODL E-Tender system (Ariba) when their Technical Bids are opened. Refer clause 4.2 of the section for details
(h)	Date & Time of opening of Price of qualified bids	Bidders will get mail intimation from TPWODL E-Tender system (Ariba) when their Price Bids are opened. Refer clause 4.5 of the section for details.

Note: In the event of last date specified for submission of bids and date of opening of bids is declared as a closed holiday for TPWODL's office, the last date of submission of bids and date of opening of bids will be the day following working day at appointed times.

1.4 Mandatory documents required along with the Bid

- 1.4.1 EMD of requisite value and validity.
- 1.4.2 Tender Fee in case the tender is downloaded from website
- 1.4.3 Requisite Documents for compliance to Qualification Criteria mentioned in Clause 1.7.
- 1.4.4 Duly signed and stamped 'Schedule of Deviations' as per Annexure III on bidder's letter head.
- 1.4.5 Duly signed and stamped 'Schedule of Commercial Specifications' as per Annexure-IV on bidder's letter head.
- 1.4.6 Proper authorization letter/ Power of Attorney to sign the tender on the behalf of bidder.

1.4.7 Copy of PAN, GST, PF and ESI Registration (In case any of these documents is not available with the bidder, same to be explicitly mentioned in the 'Schedule of Deviations')

Please note that in absence of any of the above documents, the bid submitted by a bidder shall be liable for rejection.

1.5. Deviation from Tender

Normally, the deviations to tender terms are not admissible and the bids with deviation are liable for rejection. Hence, the bidders are advised to refrain from taking any deviations on this Tender. Still in case of any deviations, all such deviations shall be set out by the Bidders, clause by clause in the 'Annexure III - Schedule of Deviations' and same shall be submitted as a part of the Technical Bid.

1.6. Right of Acceptance/Rejection

Bids are liable for rejection in absence of following documents:

- i. EMD of requisite value and validity.
- ii. Tender fee of requisite value.
- iii. Price Bid as per the Price Schedule mentioned in Annexure I (BOQ)
- iv. Necessary documents against compliance to Qualification Requirements mentioned at Clause 1.7 of this Tender Document
- v. Filled in Schedule of Deviations as per Annexure III
- vi. Filled in Schedule of Commercial Specifications as per Annexure IV
- vii. Receipt of Bid within the due date and time

TPWODL reserves the right to accept/reject any or all the bids without assigning any reason thereof.

1.7. Qualification Criteria

- a) The bidder should have average annual turnover of 1.00 Cr. or above for last 3 Financial Year. Bidders have to submit copy of audited Balance Sheet and P & L Account in this regard.
- b) Manufacturer have own manufacturing unit and in-house testing facilities for acceptance test as per technical specification. Bidder must submit undertaking in this regard. TPWODL reserves the right to may inspect the said manufacturing/testing facility as a proof of compliance to this parameter.
- c) The bidder should have experience of successfully executed supply order of similar material in bulk, during last 3 Financial Year. For this, Purchase Order/RC & RO copies along with the execution proof/completion certificates to be submitted in this regard.
- d) Performance certificate for 1year satisfactory performance of quoted/similar type materials from at least 1 reputed company is to be submitted or bidder should have made satisfactory supplies to Tata Power/TPWODL. Bidders have to submit copy of such performance certificate in this regard.
- e) The bidder who have earlier failed to execute the Purchase Order(s) of TPWODL/WESCO and or backlisted by TPWODL/WESCO or any other distribution utility shall not be eligible to participate in this tender.

TPWODL reserve the right to waive minor deviation, if they do not materially affected the capability of the bidder to perform the contract.

1.8. Marketing Integrity

We have a fair and competitive marketplace. The rules for bidders are outlined in the General Condition of Contracts. Bidders must agree to these rules prior to participating. In addition to other remedies available, TPWODL reserves the right to exclude a bidder from participating in future markets due to the

bidder's violation of any of the rules or obligations contained in the General Condition of Contracts. A bidder who violates the market place rules or engages in behavior that disrupts the fair execution of the marketplace, may result in restriction of a bidder from further participation in the marketplace for a length of time, depending upon the seriousness of the violation. Examples of violations include, but are not limited to:

- Failure to honor prices submitted to the marketplace
- Breach of terms as published in TENDER/NIT

1.9. Supplier Confidentiality

All information contained in this tender is confidential and shall not be disclosed, published or advertised in any manner without written authorization from TPWODL. This includes all bidding information submitted to TPWODL. All tender documents remain the property of TPWODL and all suppliers are required to return these documents to TPWODL upon request. Suppliers who do not honor these confidentiality provisions will be excluded from participating in future bidding events.

2.0 Evaluation Criteria

- The bids will be evaluated technically on the compliance to tender terms and conditions.
- The bids will be evaluated commercially on over BOQ basis (all-inclusive lowest cost) for the complete tender as calculated in Schedule of Items [Annexure I]. TPWODL however, reserves right to split the order line item wise and/or quantity wise among more than one Bidder. Hence all bidders are advised to quote their most competitive rates against each line item.
- Bidder has to mandatorily quote against each item of Schedule of Items [Annexure I]. Failing to do so, TPWODL may reject the bids.

NOTE: In case a new bidder is not registered with TPWODL, factory inspection and evaluation shall be carried out to ascertain bidder's manufacturing capability and quality procedures. However, TPWODL reserves the right to carry out factory inspection and evaluation for any bidder prior to technical qualification.

In case a bidder is found as Disqualified in the factory evaluation, their bid shall not be evaluated any further and shall be summarily rejected. The decision of TPWODL shall be final and binding on the bidder in this regard.

2.1 Price Variation Clause: The prices shall remain firm during the entire contract period.

3.0 Submission of Bid Documents

3.1 Bid Submission

Bidders are requested to submit their offer in line with this Tender document through e-tendering process.

Please note all future correspondence regarding the tender, bid submission, bid submission date extension, Pre-bid query etc. will happen only through TPWODL E-Tender system (Ariba).

No e-mail or verbal correspondence will be responded. All communication will be done strictly with the bidder who have done the above step to participate in the Tender.

Bids shall be submitted in 3 (Three) parts:

FIRST PART: "EMD" of Rs. 50,000/- (Rupees Fifty Thousand Only) shall be submitted. The EMD shall be valid for 210 days from the due date of bid submission in the form of BG / NEFT. The EMD has to be strictly in the format as mentioned in General Condition of Contract, failing which it shall not be accepted, and the bid as submitted shall be liable for rejection.

EMD shall be strictly in the format of Bank Guarantee and Original Hard Copy shall be delivered at the following address in Envelope clearly indicating Tender Reference Number, Name of Tender and Bidder

Property of TPWODL – Not to be reproduced without prior written permission of TPWODL

Name. Please note as return of EMD from Bank Account is non-standard practice the same may take more time than return of EMD BG.

Chief (Procurement & Stores)**TP WESTERN ODISHA DISTRIBUTION LIMITED****Corporate Office, Burla-768017**

Alternatively, the EMD amount can be transferred through NEFT to the below mentioned account. Receipt of the transaction shall be mailed through ARIBA to the package owner.

A/C NO.	NAME OF ACCOUNT	NAME OF THE BANK	IFS CODE	ACCOUNT TYPE
005511100001556	TP WESTERN ODISHA DISTRIBUTION LTD HQ	UNION BANK OF INDIA, BURLA (ANDHRA BANK)	UBIN0800554	CURRENT CUM FLEXI A/C

SECOND PART: “TECHNICAL BID” shall contain the following documents:

- Documentary evidence in support of qualifying criteria
- Technical literature/GTP/Type test report etc. (if applicable)
- Testing facilities (if applicable)
- No Deviation Certificate as per the Annexure III – Schedule of Deviations
- Acceptance to Commercial Terms and Conditions viz. Delivery schedule/period, payment terms etc. as per the Annexure IV – Schedule of Commercial Specifications.
- Quality Assurance Plan/Inspection Test Plan for supply items (if applicable)

The technical bid shall be properly indexed and is to be submitted through TPWODL E-tender System (Ariba) only. Hard Copy of Technical Bids need not be submitted.

THIRD PART: “PRICE BID” shall contain only the price details and strictly in format as mentioned in Annexure I along with explicit break up of basic prices, Taxes & duties, Freight etc. In case any discrepancy is observed between the item description stated in Schedule of Items mentioned in the tender and the price bid submitted by the bidder, the item description as mentioned in the tender document (to the extent modified through Corrigendum issued if any) shall prevail.

Price Bid is to be submitted in soft copy through TPWODL E-Tendering system (Ariba) only. Hard copy of Price Bid not be submitted.

The Bid prepared by the Bidder, and all correspondence and documents relating to the Bid exchanged by the Bidder and the TPWODL, shall be written in the English Language. Any printed literature furnished by the Bidder may be written in another Language, provided that this literature is accompanied by an English translation, in which case, for purposes of interpretation of the Bid, the English translation shall govern.

SIGNING OF BID DOCUMENTS:

The bid must contain the name, residence and place of business of the person or persons making the bid and must be signed and sealed by the Bidder with his usual signature. The names of all persons signing should also be typed or printed below the signature.

The Bid being submitted must be signed by a person holding a Power of Attorney authorizing him to do so, certified copies of which shall be enclosed.

The Bid submitted on behalf of companies registered with the Indian Companies Act, for the time being in force, shall be signed by persons duly authorized to submit the Bid on behalf of the Company and shall

be accompanied by certified true copies of the resolutions, extracts of Articles of Association, special or general Power of Attorney etc. to show clearly the title, authority and designation of persons signing the Bid on behalf of the Company. Satisfactory evidence of authority of the person signing on behalf of the Bidder shall be furnished with bid.

A bid by a person who affixes to his signature the word 'President', 'Managing Director', 'Secretary', 'Agent' or other designation without disclosing his principal will be rejected.

The Bidder's name stated on the Proposal shall be the exact legal name of the firm.

3.2 Contact Information

Please note all correspondence regarding the tender, bid submission, bid submission date extension, Pre-bid query etc. will happen only through TPWODL E-Tender system (Ariba).

No e-mail or verbal correspondence will be responded. All communication will be done strictly with the bidders who have participated in the Tender as elaborated in procedure for participating in tender.

Communication Details:

Package Owner:

Name: Nikhil Kumar Patel

E-Mail ID: nikhil.patel@tpwesternodisha.com

HoD- Contracts

Name: Mr. Ajit Singh

E-Mail ID: ajit.singh@tpwesternodisha.com

Chief-Contracts and Store:

Name: Mr. Rahul Kumar

E-Mail ID: rahul.kumar@tpwesternodisha.com

3.3 Bid Prices

Bidders shall quote for the entire Scope of Supply/ work with a break up of prices for individual items and Taxes & duties. The bidder shall complete the appropriate Price Schedules included herein, stating the Unit Price for each item & total price with taxes, duties & freight up to destination at various sites of TPWODL. The all-inclusive prices offered shall be inclusive of all costs as well as Duties, Taxes and Levies paid or payable during the execution of the supply work, breakup of price constituents.

Applicable GST to be specified clearly.

The quantity break up shown else-where other than Price Schedule is tentative. The bidder shall ascertain himself regarding material required for completeness of the entire work. Any items not indicated in the price schedule but which are required to complete the job as per the Technical Specifications/ Scope of Work/ SLA mentioned in the tender, shall be deemed to be included in prices quoted.

3.4 Bid Currencies

Prices shall be quoted in Indian Rupees Only.

3.5 Period of Validity of Bids

Bids shall remain valid for 180 days from the due date of submission of the bid.

Notwithstanding clause above, the TPWODL may solicit the Bidder's consent to an extension of the Period of Bid Validity. The request and responses thereto shall be made in writing.

RC Validity: - The validity of this rate contract shall be one year from the date of issuance.

3.6 Alternative Bids

Bidders shall submit Bids, which comply with the Bidding documents. Alternative bids will not be considered. The attention of Bidders is drawn to the provisions regarding the rejection of Bids in the terms and conditions, which are not substantially responsive to the requirements of the bidding documents.

3.7 Modifications and Withdrawal of Bids

The bidder is not allowed to modify or withdraw its bid after the Bid's submission. The EMD as submitted along with the bid shall be liable for forfeiture in such event.

3.8 Earnest Money Deposit (EMD)

The bidder shall furnish, as part of its bid, an EMD amounting as specified in the tender. The EMD is required to protect TPWODL against the risk of bidder's conduct which would warrant forfeiture.

The EMD shall be forfeited in case of:

a) The bidder withdraws its bid during the period of specified bid validity.

Or

b) The case of a successful bidder, if the Bidder does not

i) accept the purchase order, or

ii) furnish the required performance security BG

4 Bid Opening & Evaluation process

4.1. Process to be confidential

Information relating to the examination, clarification, evaluation and comparison of Bids and recommendations for the award of a contract shall not be disclosed to Bidders or any other persons not officially concerned with such process. Any effort by a Bidder to influence the TPWODL's processing of Bids or award decisions may result in the rejection of the Bidder's Bid.

4.2. Technical Bid Opening

The bids shall be opened internally by TPWODL. First the envelope marked "EMD" will be opened. Bids without EMD/ cost of tender (if applicable) of required amount/ validity in prescribed format, shall be rejected.

Next, technical bids of bidders who have submitted EMD shall be opened. Participating Bidders will get mail intimation from TPWODL E-Tender system (Ariba) when their Technical Bids are opened.

4.3. Preliminary Examination of Bids/Responsiveness

TPWODL will examine the Bids to determine whether they are complete, whether any computational errors have been made, whether required sureties have been furnished, whether the documents have been properly signed, and whether the Bids are generally in order. TPWODL may ask for submission of original documents in order to verify the documents submitted in support of qualification criteria.

Arithmetical errors will be rectified on the following basis: If there is a discrepancy between the unit price and the total price per item that is obtained by multiplying the unit price and quantity, the unit price shall prevail and the total price per item will be corrected. If there is a discrepancy between the Total Amount and the sum of the total price per item, the sum of the total price per item shall prevail and the Total Amount will be corrected.

Prior to the detailed evaluation, TPWODL will determine the substantial responsiveness of each Bid to the Bidding Documents including production capability and acceptable quality of the Goods offered. A substantially responsive Bid is one, which conforms to all the terms and conditions of the Bidding Documents without material deviation.

Bid determined as not substantially responsive will be rejected by the TPWODL and/or the TPWODL and may not subsequently be made responsive by the Bidder by correction of the non-conformity.

4.4. Techno Commercial Clarifications

Bidders need to ensure that the bids submitted by them are complete in all respects. To assist in the examination, evaluation and comparison of Bids, TPWODL may, at its discretion, ask the Bidder for a clarification on its Bid for any deviations with respect to the TPWODL specifications and attempt will be made to bring all bids on a common footing. All responses to requests for clarification shall be in writing and no change in the price or substance of the Bid shall be sought, offered or permitted owing to any clarifications sought by TPWODL.

4.5. Price Bid Opening

Price Bid of only Technically and / or Safety Qualified Bidders shall be considered and open internally by TPWODL. Bidders will get mail intimation from TPWODL E-Tender system (Ariba) when their Price Bids are opened. The EMD of the bidder withdrawing or substantially altering his offer at any stage after the technical bid opening will be forfeited at the sole discretion of TPWODL without any further correspondence in this regard.

4.6. Reverse Auctions

TPWODL reserves the right to conduct the reverse auction (instead of public opening of price bids) for the products/ services being asked for in the tender. The terms and conditions for such reverse auction events shall be as per the Acceptance Form attached as Annexure VI of this document. The bidders along with the tender document shall mandatorily submit a duly signed copy of the Acceptance Form attached as Annexure VI as a token of acceptance for the same.

5 Award Decision

TPWODL will award the contract to the successful bidder whose bid has been determined to be the lowest-evaluated responsive bid as per the Evaluation Criterion mentioned at Clause 2.0. The Cost for the said calculation shall be taken as the all-inclusive cost quoted by bidder in Annexure I (Schedule of Items) subject to any corrections required in line with Clause 4.3 above. The decision to place purchase order/LOI solely depends on TPWODL on the cost competitiveness across multiple lots, quality, delivery and bidder's capacity, in addition to other factors that TPWODL may deem relevant.

TPWODL reserves all the rights to award the contract to one or more bidders so as to meet the delivery requirement or nullify the award decision without assigning any reason thereof.

In case any supplier is found unsatisfactory during the delivery process, the award will be cancelled and TPWODL reserves the right to award other suppliers who are found fit.

NOTE: Please note that Intimation of Price Bid Opening will go only to those bidders who are Technically Acceptable and whose price bid are opened. Bidders who are not successful in technical or commercial part of the process will be intimated to collect EMD only after end of process.

It is informed that TPWODL shall not provide status updates or give explanation of process followed for bidder selection criteria whatsoever, to any participating bidder.

6 Order of Preference/Contradiction

In case of contradiction in any part of various documents in tender, following shall prevail in order of preference:

1. Schedule of Items (Annexure I)
2. Post Award Contract Administration (Clause 7.0)
3. Submission of Bid Documents (Clause 3.0)
4. Scope of Work and SLA (Annexure VII)
5. Technical Specifications (Annexure II)
6. Acceptance Form for Participation in Reverse Auction (Annexure VI)
7. General Conditions of Contract (Annexure VIII)

7 Post Award Contract Administration

7.1. Special Conditions of Contract

- Rate contract shall be valid for a period of 1 years from the placement of Contract. Release Order (RO) shall be placed as per the requirement of TPWODL. Rate shall remain FIRM till the validity of Rate Contract.
- Business Associate (BA) shall submit applicable Performance Bank Guarantee as per GCC within 30 days of issuance of order. PBG applicable shall be 5% of Order Value. PBG submitted, shall be released after completion of applicable guarantee period plus one month.
- Any change in statutory taxes, duties and levies during the contract period shall be borne by TPWODL. However, in case of delay in work execution owing to reasons not attributable to TPWODL, any increase in total liability shall be passed on the Bidder, whereas any benefits arising owing to such statutory variation in taxes and duties shall be passed on TPWODL.
- Statutory Variations: Any changes in existing taxes/ Duties and levies, Introduction of new taxes and duties etc. during the period of the contract shall be paid at actuals to BA subject to BA shall submit the tax break up in details, however, where BA has quoted the all-inclusive prices and not shown the tax break-up, this clause will not be applicable. The date of issue of MDCC shall be used for this purpose.
- Quotation in all BOM items is mandatory, and bid shall be rejected if any line of found blank in un price bid.
- There will be no price escalation given to bidder after issue the RO even if there is delayed the project due to ROW permission.
- Quotation in all BOM items is mandatory, and bid shall be rejected if any line of found blank in un price bid.
- In case any additional material is to be asked to supply after finalization of scope of work in the detailed Engineering, the Extra price and the extension of delivery time (if applicable) as the case may be mutually agreed between TPWODL and Successful Bidder.
- All other terms and conditions of TPWODL General Conditions of Contract shall be applicable.

7.2 Drawing Submission and Approval

The relevant drawings and GTPs need to be submitted within two weeks of receipt of firm purchase order by the successful bidder to TPWODL for approval. In case, re-submission of drawings is required on request of TPWODL, same needs to be submitted back to TPWODL within 5 days of such request.

7.3 Delivery Timelines

Release Orders shall be placed against the awarded Rate Contract by TPWODL as and when the requirements arise & Delivery within 30 Days from RO.

7.4 Guarantee/Warranty Period

Guarantee Period of the supplies materials will be 24 months from the date of last supplies made under the contract.

7.5 Payment Terms

On delivery of the materials in good condition and certification of acceptance by certified official, Associate shall submit the Bills/ Invoices in original in the name of TP Western Odisha Distribution Limited to Invoice Desk. The payment shall be released within 60 days from the date of submission of certified bills/ invoices.

7.6 Climate Change

Significant quantities of waste are generated during the execution of project and an integrated approach for effective handling, storage, transportation and disposal of the same shall be adopted. This would ensure the minimization of environmental and social impact in order to combat the climate change. Please refer attached Environment Policy and Sustainability Policy, Annexure-XI for more details.

7.7 Ethics

TPWODL is an ethical organization and as a policy TPWODL lays emphasis on ethical practices across its entire domain. Bidder should ensure that they should abide by all the ethical norms and in no form either directly or indirectly be involved in unethical practice.

TPWODL work practices are governed by the Tata Code of Conduct which emphasizes on the following:

- We shall select our suppliers and service providers fairly and transparently.
- We seek to work with suppliers and service providers who can demonstrate that they share similar values. We expect them to adopt ethical standards comparable to our own.
- Our suppliers and service providers shall represent our company only with duly authorized written permission from our company. They are expected to abide by the Code in their interactions with, and on behalf of us, including respecting the confidentiality of information shared with them.
- We shall ensure that any gifts or hospitality received from, or given to, our suppliers or service providers comply with our company's gifts and hospitality policy.
- We respect our obligations on the use of third party intellectual property and data.

Bidder is advised to refer Tata Code of Conduct (TCOC) attached at Annexure IX for more information.

Any ethical concerns with respect to this tender can be reported to the following e-mail ID:

sunilk.sharma@tpwesternodisha.com

8 Specification and standards

As per Annexure II

9 General Condition of Contract

Any condition not mentioned above shall be applicable as per GCC Annexure-VIII attached along with this tender.

ANNEXURE I
Schedule of Items

Sl. No.	Item Description	Qty.	UoM	Unit Basic Price	GST @	Unit Price inclusive of taxes & charges	Total Price, all inclusive (in Rs.)
1	120kN (B&S) Hardware Fittings	6,000	EA				
2	90kN (B&S) Hardware Fitting	6,000	EA				
Total Package Value:							

All the items mentioned above should be supplied along with respective fittings.

N.B.:-

1. Type test report for offered materials is to be submitted along with the offer.
2. GTP in prescribed format shall be submitted along with the offer.

NOTE:

- The overall period of the rate contract shall be for a period of 1 year and prices shall be firm till the validity of contract. Release order shall be issued as per requirement of TPWODL.
- The bids will be evaluated commercially on the lowest cost in total BOQ basis.
- The unit price with GST in col no.7, is landed price for TPWODL at their store at Burla/site. Refer Clause-3.3 Bid Price.
- The bidders are advised to quote prices strictly in the above format. Failing to do so, bids are liable for rejection.
- Bidder needs to quote mandatorily for each line item of the BOQ.
- The bidder must fill each and every column of the above format. Mentioning “extra/inclusive” in any of the column may lead for rejection of the price bid.
- No cutting/ overwriting in the prices is permissible.
- The material will be received by the consignee in the Electrical Stores Sub division under TPWODL as per dispatch instruction.
- Drawing of the offer materials is to be submitted along with the offer.
- Type test report for offered materials is to be submitted along with the offer.



NIT: TPWODL/NP/O/SU/024

TP WESTERN ODISHA DISTRIBUTION LIMITED
(A Tata Power & Odisha Govt. joint venture)
Corporate Office, Burla-768 017

ANNEXURE II

Technical Specification
(Attached Separately)

TP WESTERN ODISHA DISTRIBUTION LIMITED
(A Tata Power & Odisha Govt. joint venture)
Corporate Office, Burla-768 017

ANNEXURE III

Schedule of Deviations

*Bidders are advised to refrain from taking any deviations on this TENDER. Still in case of any deviations, all such deviations from this tender document shall be set out by the Bidders, Clause by Clause in this schedule and submit the same as a part of the **Technical Bid**.*

*Unless **specifically** mentioned in this schedule, the tender shall be deemed to confirm the TPWODL's specifications:*

S. No.	Clause No.	Tender Clause Details	Details of deviation with justifications

By signing this document we hereby withdraw all the deviations whatsoever taken anywhere in this bid document and comply to all the terms and conditions, technical specifications, scope of work etc. as mentioned in the standard document except those as mentioned above.

Seal of the Bidder:

Signature:

Name:

TP WESTERN ODISHA DISTRIBUTION LIMITED
 (A Tata Power & Odisha Govt. joint venture)
 Corporate Office, Burla-768 017

ANNEXURE IV

Schedule of Commercial Specifications

(The bidders shall mandatorily fill in this schedule and enclose it with the offer Part I: Technical Bid. In the absence of all these details, the offer may not be acceptable.)

S. No.	Particulars	Remarks
1.	Prices firm or subject to variation (If variable indicate the price variation clause with the ceiling if applicable)	Firm / Variable
1a.	If variable price variation on clause given	Yes / No
1b.	Ceiling	----- %
1c.	Inclusive of GST	Yes / No (If Yes, indicate % rate)
1d.	Inclusive of transit insurance	Yes / No
2.	Delivery	Weeks / months
3.	Guarantee clause acceptable	Yes / No
4.	Terms of payment acceptable	Yes / No
5.	Performance Bank Guarantee acceptable	Yes / No
6.	Liquidated damages clause acceptable	Yes / No
7.	Validity (180 days) (From the date of opening of bid)	Yes / No
8.	Inspection during stage of manufacture	Yes / No
9.	Rebate for increased quantity	Yes / No (If Yes, indicate value)
10.	Change in price for reduced quantity	Yes / No (If Yes, indicate value)
11.	Covered under Small Scale and Ancillary Industrial Undertaking Act 1992	Yes / No (If Yes, indicate, SSI Reg'n No.)

Seal of the Bidder:

Signature:

Name:

TP WESTERN ODISHA DISTRIBUTION LIMITED
(A Tata Power & Odisha Govt. joint venture)
Corporate Office, Burla-768 017

ANNEXURE V

Checklist of all the documents to be submitted with the Bid

Bidder has to mandatorily fill in the checklist mentioned below:

S. No.	Documents attached	Yes / No / Not Applicable
1	EMD of required value	
2	Tender Fee as mentioned in this tender	
3	Signed copy of this tender as an unconditional acceptance	
5	Duly filled schedule of commercial specifications (Annexure IV)	
6	Sheet of commercial/technical deviation if any (Annexure III)	
7	Balance sheet for the last completed three financial years; mandatorily enclosing Profit & loss account statement	
8	Acknowledgement for Testing facilities if available (duly mentioned on bidder letter head)	
9	List of Machine/tools with updated calibration certificates if applicable	
10	Details of order copy (duly mentioned on bidder letter head)	
11	Order copies as a proof of quantity executed	
12	Details of Type Tests if applicable (duly mentioned on bidder letter head)	
13	All the relevant Type test certificates as per relevant IS/IEC (CPRI/ERDA/other certified agency) if applicable	
14	Project/supply Completion certificates	
15	Performance certificates	
16	Client Testimonial/Performance Certificates	
17	Credit rating/solvency certificate	
18	Undertaking regarding non blacklisting (On company letter head)	
19	List of trained/untrained Manpower	

Seal of the Bidder:

Signature:

Name:

TP WESTERN ODISHA DISTRIBUTION LIMITED
(A Tata Power & Odisha Govt. joint venture)
Corporate Office, Burla-768 017

ANNEXURE VI

ACCEPTANCE FORM FOR PARTICIPATION IN REVERSE AUCTION EVENT

(To be signed and stamped by the bidder)

In a bid to make our entire procurement process more fair and transparent, TPWODL intends to use the reverse auctions as an integral part of the entire tendering process. All the bidders who are found as technically qualified based on the tender requirements shall be eligible to participate in the reverse auction event.

The following terms and conditions are deemed as accepted by the bidder on participation in the bid event:

1. TPWODL shall provide the user id and password to the authorized representative of the bidder. *(Authorization Letter in lieu of the same shall be submitted along with the signed and stamped Acceptance Form).*
2. TPWODL will make every effort to make the bid process transparent. However, the award decision by TPWODL would be final and binding on the supplier.
3. The bidder agrees to non-disclosure of trade information regarding the purchase, identity of TPWODL, bid process, bid technology, bid documentation and bid details.
4. The bidder is advised to understand the auto bid process to safeguard themselves against any possibility of non-participation in the auction event.
5. In case of bidding through Internet medium, bidders are further advised to ensure availability of the entire infrastructure as required at their end to participate in the auction event. Inability to bid due to telephone line glitch, internet response issues, software or hardware hangs, power failure or any other reason shall not be the responsibility of TPWODL.
6. In case of intranet medium, TPWODL shall provide the infrastructure to bidders. Further, TPWODL has sole discretion to extend or restart the auction event in case of any glitches in infrastructure observed which has restricted the bidders to submit the bids to ensure fair & transparent competitive bidding. In case of an auction event is restarted, the best bid as already available in the system shall become the start price for the new auction.
7. In case the bidder fails to participate in the auction event due any reason whatsoever, it shall be presumed that the bidder has no further discounts to offer and the initial bid as submitted by the bidder as a part of the tender shall be considered as the bidder's final no regret offer. Any offline price bids received from a bidder in lieu of non-participation in the auction event shall be out-rightly rejected by TPWODL.
8. The bidder shall be prepared with competitive price quotes on the day of the bidding event.
9. The prices as quoted by the bidder during the auction event shall be inclusive of all the applicable taxes, duties and levies and shall be FOR at TPWODL site.
10. The prices submitted by a bidder during the auction event shall be binding on the bidder.
11. No requests for time extension of auction event shall be considered by TPWODL.
12. The original price bids of the bidders shall be reduced on pro-rata basis against each line item based on the final all-inclusive prices offered during conclusion of the auction event for arriving at Contract amount.

Signature & Seal of the Bidder

TP WESTERN ODISHA DISTRIBUTION LIMITED
(A Tata Power & Odisha Govt. joint venture)
Corporate Office, Burla-768 017

ANNEXURE VII
Scope of Work

NA



NIT: TPWODL/NP/O/SU/024

TP WESTERN ODISHA DISTRIBUTION LIMITED
(A Tata Power & Odisha Govt. joint venture)
Corporate Office, Burla-768 017

ANNEXURE- VIII

GENERAL CONDITIONS OF CONTRACT FOR SUPPLY ORDERS

(Attached Separately)

TP WESTERN ODISHA DISTRIBUTION LIMITED
(A Tata Power & Odisha Govt. joint venture)
Corporate Office, Burla-768 017

ANNEXURE-IX

TATA CODE OF CONDUCT

The Owner abides by the Tata Code of Conduct in all its dealing with stake holders and the same shall be binding on the Owner and the Contractor for dealings under this Order/ Contract. A copy of the Tata Code of Conduct is available a tour website:

<https://www.tatapower.com/pdf/aboutus/Tata-Code-of-Conduct.pdf>

The Contractor is requested to bring any concerns regarding this to the notice of our Chief Procurement & Stores e-mail ID: sunilk.sharma@tpwesternodisha.com

TP WESTERN ODISHA DISTRIBUTION LIMITED
(A Tata Power & Odisha Govt. joint venture)
Corporate Office, Burla-768 017

ANNEXURE X

ENVIRONMENT & SUSTAINABILITY POLICY



CORPORATE ENVIRONMENT POLICY

Tata Power is committed to a clean, safe and healthy environment, and we shall operate our facilities in an environmentally sensitive and responsible manner. Our commitment to environmental protection and stewardship will be achieved by:

- Complying with the requirements and spirit of applicable environmental laws and striving to exceed required levels of compliance wherever feasible
- Ensuring that our employees are trained to acquire the necessary skills to meet environmental standards
- Conserving natural resources by improving efficiency and reducing wastage
- Making business decisions that aim towards sustainable development
- Engaging with stakeholders to create awareness on sustainability

(Praveer Sinha)
CEO & Managing Director

Date: 15th June, 2018

TATA POWER
Lighting up Lives!



TP WESTERN ODISHA DISTRIBUTION LIMITED
(A Tata Power & Odisha Govt. joint venture)
Corporate Office, Burla-768 017



CORPORATE SUSTAINABILITY POLICY

At Tata Power, our Sustainability Policy integrates economic progress, social responsibility and environmental concerns with the objective of improving quality of life. We believe in integrating our business values and operations to meet the expectations of our customers, employees, partners, investors, communities and public at large

- We will uphold the values of honesty, partnership and fairness in our relationship with stakeholders
- We shall provide and maintain a clean, healthy and safe working environment for employees, customers, partners and the community
- We will strive to consistently enhance our value proposition to the customers and adhere to our promised standards of service delivery
- We will respect the universal declaration of human rights, International Labour Organization's fundamental conventions on core labour standards and operate as an equal opportunities employer
- We shall encourage and support our partners to adopt responsible business policies, Business Ethics and our Code of Conduct Standards
- We will continue to serve our communities:
 - By implementing sustainable Community Development Programmes including through public/private partnerships in and around our area of operations
 - By constantly protecting ecology, maintaining and renewing bio-diversity and wherever necessary conserving and protecting wild life, particularly endangered species
 - By encouraging our employees to serve communities by volunteering and by sharing their skills and expertise
 - By striving to deploy sustainable technologies and processes in all our operations and use scarce natural resources efficiently in our facilities
 - We will also help communities that are affected by natural calamities or untoward incidence, or that are physically challenged in line with the Tata Group's efforts

The management will commit all the necessary resources required to meet the goals of Corporate Sustainability.

(Praveer Sinha)
CEO & Managing Director

Date: 15th June, 2018

TATA POWER
Lighting up Lives!



TP WESTERN ODISHA DISTRIBUTION LIMITED
(A Tata Power & Odisha Govt. joint venture)
Corporate Office, Burla-768 017

ANNEXURE-XI

Norms for procurement from MSMEs registered in the state of Odisha

1) Tender Fees

To participate in the tender, MSMEs registered in the State of Odisha shall pay Rs.1,000/- including GST towards cost of tender paper.

2) Earnest Money Deposit (EMD)

EMD shall be exempted for MSME registered in the State of Odisha. However, Bidder shall be barred to participate in the tendering process for a period of 2 years in case it backs out post award of the contract.

3) Qualification Requirement for Open Tenders

Qualification Requirement of Financial Turnover for MSME registered in the State of Odisha shall be reduced to 20% of the existing criteria.

4) Performance Bank Guarantees

Performance Bank Guarantee for MSME registered in the State of Odisha shall be 25% of the value prescribed.

Technical Specifications
(Annexure to Tender Documents)

CONFIDENTIAL

	TP WESTERN ODISHA DISTRIBUTION LTD	Page 1 of 10
DOCUMENT TITLE	SPECIFICATION FOR DISC INSULATOR HARDWARE FITTINGS (70KN, 90KN & 120KN)	EFFECTIVE DATE 13/05/2022
DOCUMENT NUMBER:	ENG-MCH-032	REVISION NO: R0

CONTENTS

1. SCOPE
2. APPLICABLE STANDARDS
3. CLIMATIC CONDITIONS OF THE INSTALLATION
4. GENERAL TECHNICAL REQUIREMENTS
5. GENERAL CONSTRUCTIONS
6. MARKING
7. TESTS
8. TYPE TEST CERTIFICATES
9. PRE-DISPATCH INSPECTION
10. INSPECTION AFTER RECEIPT AT STORES
11. GUARANTEE
12. PACKING
13. TENDER SAMPLE
14. QUALITY CONTROL
15. TESTING FACILITIES
16. MANUFACTURING ACTIVITIES
17. SPARES, ACCESSORIES AND TOOLS
18. DRAWINGS AND DOCUMENTS
19. SCHEDULE "A" GUARANTEED TECHNICAL PARTICULARS
20. SCHEDULE "B" DEVIATIONS

TPWODL	TP WESTERN ODISHA DISTRIBUTION LTD	Page 2 of 10
DOCUMENT TITLE	SPECIFICATION FOR DISC INSULATOR HARDWARE FITTINGS (70KN, 90KN & 120KN)	EFFECTIVE DATE 13/05/2022
DOCUMENT NUMBER:	ENG-MCH-032	REVISION NO: R0

1. SCOPE

The Specification covers the design, manufacture, testing preferably at manufacturer's works before supply and delivery of combined unit of hardware fittings for string insulators suitable for use in 33kV and 11kV overhead power lines.

The combined units offered shall be complete with all components which are necessary (excepting disc insulator) or usual for their effective performance and easy maintenance and inter changeability at site. Such parts shall be deemed to be within the scope of contract.

2. APPLICABLE STANDARDS

The equipment covered by this specification shall unless otherwise stated, be designed, manufactured and tested in accordance with the latest editions of the following Indian, International Standards and shall conform to the regulations of the local authorities:

Ref. IS	Description
IS 2486 (Part 1) IS 2486 (Part 2) IS 2486 (Part 3)	Specification for metal fittings of insulators for overhead power lines with nominal voltage greater than 1000 V. Specification for Insulator fittings for overhead power lines with nominal voltage greater than 1000V. (dimensional requirements) Specification for Insulator fittings for overhead power lines with nominal voltage greater than 1000 V. (locking devices)
IS 4759	Specification for hot-dip zinc coatings on structural steel and other allied products.
IS : 6745	Determination of mass of zinc coating on zinc coated iron and steel articles.
IS : 2633	Method for testing uniformity of coating on zinc coated.
IS 6603	Stainless Steel Bars and Flats
IS 2016	Plain washers
IS:1573	Specification for electroplated coatings of zinc on iron and steel.
IS 209	Specification of Zinc
IS 6639, BS:916	Specification for Hexagonal bolts and nuts

TPWODL	TP WESTERN ODISHA DISTRIBUTION LTD	Page 3 of 10
DOCUMENT TITLE	SPECIFICATION FOR DISC INSULATOR HARDWARE FITTINGS (70KN, 90KN & 120KN)	EFFECTIVE DATE 13/05/2022
DOCUMENT NUMBER:	ENG-MCH-032	REVISION NO: R0

3. CLIMATIC CONDITIONS OF THE INSTALLATION:

SL.NO.	CONDITONS	VALUES
1	Max. altitude above sea level	1000m
2	Max. Ambient Temperature	50 °C
3	Max. Daily average ambient temp	35 °C
4	Min Ambient Temp	0 °C
5	Maximum temperature attainable by an object exposed to sun	60 °C
6	Maximum Humidity	95%
7	Minimum Humidity	10%
8	Average No. of thunderstorm days per annum	70
9	Average Annual Rainfall	150 cm
10	Average No. of rainy days per annum	120
11	Thermal Resistivity of soil	150 Deg. Cm/W
12	Wind Pressure	126 kg/sq. m up to an elevation of 10 meter.
14	Earthquakes of intensity in horizontal direction	equivalent to seismic acceleration of 0.3g
15	Earthquakes of intensity in vertical direction	equivalent to seismic acceleration of 0.15g
16	Wind velocity	200 km/hr.

Environmentally, some of the regions, where the work will take place includes hilly areas, subject to high relative humidity, which can give rise to condensation. Atmosphere is generally laden with mild acid and dust due to industrial activities. Some places are in heavily industrial polluted areas. On occasions, the combination of humid, acidic and dust condensation may create pollution conditions for outdoor equipment's. Therefore, outdoor materials and equipment's shall be designed and protected for use exposed, heavily polluted, acidic, corrosive, tropical and humid atmosphere.

4. GENERAL TECHNICAL REQUIREMENTS:

- i) All ferrous parts including fasteners shall be hot dip galvanized, after all machining has been completed. Nuts may however be tapped (threaded) after galvanizing and the threads oiled. Spring washers shall be electro-galvanized. The bolt threads shall be undercut to take care of the increase in diameter due to galvanizing. Galvanizing shall be done in accordance

DOCUMENT TITLE	SPECIFICATION FOR DISC INSULATOR HARDWARE FITTINGS (70KN, 90KN & 120KN)	EFFECTIVE DATE 13/05/2022
DOCUMENT NUMBER:	ENG-MCH-032	REVISION NO: R0

with IS-2629-1985 and shall satisfy the tests mentioned in IS: 2633-1986. Fasteners shall withstand four dips while spring washers shall withstand three dips of one-minute duration in the standard Preece test. Other galvanized materials shall be guaranteed to withstand at least six successive dips each lasting one minute under the Standard Preece test for galvanizing.

- ii) The zinc coating shall be perfectly adherent of uniform thickness, smooth, reasonably bright, continuous and free from imperfections such as flux, ash, rust stains, bulky white deposits and blisters. The zinc used for galvanizing shall be of grade Zn 99.95 as per IS 209.

SL. NO.	TECHNICAL PARTICULARS	DESIRED VALUE		
1	Type	B&S type		
2	Ultimate Strength	70 KN (3 Bolted)	90 KN (4 Bolted)	120 KN (4 Bolted)
3	Suitable for conductor Size	AAAC-80 Sq mm, 100 Sq mm	AAAC-148 Sq mm	AAAC-232 Sq mm
4	Slip strength of tension clamp	95% of UTS	95% of UTS	95% of UTS
5	Referred IS Standard	IS 2486	IS 2486	IS 2486
6	Material Used			
a)	Cross Arm Strap	Mild Steel (HDG)	Mild Steel (HDG)	Mild Steel (HDG)
b)	Ball Eye	Forged Steel	Forged Steel	Forged Steel
c)	Socket Eye	Forged Steel	Forged Steel	Forged Steel
d)	Bolted Type Tension Clamp and Keeper	Aluminum Alloy	Aluminum Alloy	Aluminum Alloy
e)	Security Clip	Stainless steel	Stainless steel	Stainless steel
f)	Split Pin	Stainless steel	Stainless steel	Stainless steel
g)	Cotter Pin and Bolt	Mild Steel (HDG)	Mild Steel (HDG)	Mild Steel (HDG)
h)	Nuts	Mild Steel (HDG)	Mild Steel (HDG)	Mild Steel (HDG)
i)	Spring Washer	Mild Steel (HDG)	Mild Steel (HDG)	Mild Steel (HDG)
j)	Plain Washer	Mild Steel (HDG)	Mild Steel (HDG)	Mild Steel (HDG)
k)	Zn confirming to grade	IS 209	IS 209	IS 209
m)	Size of U Bolt	M16	M16	M16
7	Galvanizing	IS 2633, IS 2629	IS 2633, IS 2629	IS 2633, IS 2629

5. GENERAL CONSTRUCTIONS:

5.1 Fittings for Strain Insulators with clamp

- i) Cross arm strap confirming to IS 2486 (Part 2). Forged Steel ball eye for attaching the socket end of the Disc insulator to the cross arm strap. Dimensions shall be in accordance with IS: 2486 (Part-2) unless otherwise specified.

TPWODL	TP WESTERN ODISHA DISTRIBUTION LTD	Page 5 of 10
DOCUMENT TITLE	SPECIFICATION FOR DISC INSULATOR HARDWARE FITTINGS (70KN, 90KN & 120KN)	EFFECTIVE DATE 13/05/2022
DOCUMENT NUMBER:	ENG-MCH-032	REVISION NO: R0

- ii) Cross-arm straps shall be manufactured from MS Flat hot dip galvanized and to connect the cross-arm/bracket of the structure at one end and the Ball Clevis at the other end.
- iii) It should be complete with hexagonal bolts, nuts, spring washers and Cotter pin at the threaded end to lock the unit. Minimum Threaded portion of the bolt shall be 30mm.
- iv) Aluminum alloy thimble socket made of permanent high strength aluminum alloy for attaching the disc insulator at one end and for accommodating the loop of conductor at the other end. The thimble socket shall be attached to the disc insulator with the help of locking pin as per the dimensions given in IS:2486 (Part 2).
- v) The tension hardware with three bolts and four bolts strain hardware shall have minimum slip strength not less than 95% of the strength of respective conductor.
- vi) All forgings & castings shall be of good finish and free from flaws or any other defects which may cause decrement of efficiency while in operation. The edges on the outside of the fittings such as at the ball socket & holes and the grooves shall be smooth & rounded. Sharp radius of curvature, ridges etc. which may lead to localized pressure or cause damage to the conductors in service shall be avoided. The clamp shall permit the conductor to slip before the failure of conductor occurs.
- vii) All parts of different fittings which provide for interconnection shall be made such that sufficient clearance is provided at the connection point to ensure free movement. All ball and socket connections shall be free in this manner, but care shall be taken that too much clearance between ball and socket is avoided.
- viii) All ferrous fittings and the parts other than those of stainless steel, shall be galvanized. Small fittings like spring washers, nuts, etc. should be electro-galvanized-Coating thickness as per IS: 1573.
- ix) The nominal dimensions of the ball and sockets, ball eye and cross-arm straps are as per the IS:2486 (Part 2).

5.2 FASTENERS: Bolts, Nuts & Washers:

- i) All bolts and nuts shall conform to IS-6639. U bolt, Hexagonal Bolt, Nut, Plain Washer and all other ferrous parts shall be Hot dip Galvanized. In case of Hot Dip Galvanization, minimum Value of Mass of zinc coating should be 705 g/m². All bolts and nuts shall have hexagonal heads, the heads being truly concentric, and square with the shank, which must be perfectly straight.
- ii) Flat washers and spring washers shall be provided wherever necessary and shall be of positive lock type. Spring washers shall be electro-galvanized. The thickness of washers shall conform to IS-2016.
- iii) The split pin to be used on the cotter pin shall be of Humpback type & shall be made of

	TP WESTERN ODISHA DISTRIBUTION LTD	Page 6 of 10
DOCUMENT TITLE	SPECIFICATION FOR DISC INSULATOR HARDWARE FITTINGS (70KN, 90KN & 120KN)	EFFECTIVE DATE 13/05/2022
DOCUMENT NUMBER:	ENG-MCH-032	REVISION NO: R0

Stainless Steel conforming to IS: 6603 with a minimum hardness of 160 HV.

- iv) Locking devices (R Type) for ball and socket lockers shall be of Stainless Steel conforming to IS: 6603 with minimum hardness of 160 HV. The dimension shall conform to IS: 2486.

6. MARKING:

Each Hardware fittings shall be legibly and indelibly marked (embossing/engraved) to show the following:

- a) Name & Trade mark of the manufacturer
- b) Year of manufacturing
- c) Minimum failing load in KN
- d) "TPWODL"

7. TESTS

The bidder shall be required to submit complete set of the following test reports along with the offer: -

7.1 ACCEPTANCE TESTS

For Clamps

- i) Visual Examination Test
- ii) Chemical Composition Test
- iii) Verification of dimensions
- iv) Mechanical Test
- v) Ultimate Strength Test
- vi) Galvanizing Test
- vii) Electrical resistance test

On Insulator string fittings

- i) Visual Examination
- ii) Chemical Composition Test
- iii) Verification of dimensions
- iv) Ultimate Strength Test
- v) Galvanizing Test

7.2 ROUTINE TESTS

- i) Visual Examination Test
- ii) Mechanical Routine Test

	TP WESTERN ODISHA DISTRIBUTION LTD	Page 7 of 10
DOCUMENT TITLE	SPECIFICATION FOR DISC INSULATOR HARDWARE FITTINGS (70KN, 90KN & 120KN)	EFFECTIVE DATE 13/05/2022
DOCUMENT NUMBER:	ENG-MCH-032	REVISION NO: R0

7.3 TYPE TESTS

For Clamps

- i) Visual Examination
- ii) Verification of dimensions
- iii) Slip strength tests
- iv) Ultimate Strength test
- v) Electrical resistance test
- vi) Heating Cycle test
- vii) Galvanizing/ Electroplating Test

On Insulator string fittings except Clamps

- i) Visual Examination
- ii) Verification of dimensions
- iii) Mechanical Test
- iv) Galvanizing Test
- v) Chemical Composition Test

8. TYPE TEST CERTIFICATES:

The Bidder shall furnish the type test certificates of the for the tests as mentioned above as per the corresponding standards. All the tests shall be conducted at **CPRI/ERDA/Other Government Labs** as per the relevant IS/IEC. Type tests should have been conducted during the period not exceeding 5 years from the date of opening the bid. In the event of any discrepancy in the test reports, i.e. any test report not acceptable, same shall be carried out without any cost implication to TPWODL.

9. PRE DISPATCH INSPECTION:

The material shall be subject to inspection by a duly authorized representative of the TPWODL. Inspection may be made at any stage of manufacture at the discretion of the purchaser and the equipment, if found unsatisfactory as to workmanship or material, the same is liable to rejection. Bidder shall grant free access to the places of manufacture to TPWODL's representatives at all times when the work is in progress. Inspection by the TPWODL or its authorized representatives shall not relieve the bidder of his obligation of furnishing equipment in accordance with the specifications. Material shall be dispatched after specific MDCC (Material Dispatch Clearance Certificate) is issued by TPWODL.

Following documents shall be sent along with material.

	TP WESTERN ODISHA DISTRIBUTION LTD	Page 8 of 10
DOCUMENT TITLE	SPECIFICATION FOR DISC INSULATOR HARDWARE FITTINGS (70KN, 90KN & 120KN)	EFFECTIVE DATE 13/05/2022
DOCUMENT NUMBER:	ENG-MCH-032	REVISION NO: R0

- a) Test reports
- b) MDCC issued by TPWODL
- c) Invoice in duplicate
- d) Packing list
- e) Drawings & catalogue
- f) Guarantee / Warrantee card
- g) Delivery Challan
- h) Other Documents (as applicable).

10. INSPECTION AFTER RECEIPT AT STORES:

The material received at TPWODL, Odisha store will be inspected for acceptance and shall be liable for rejection, if found different from the reports of the pre-dispatch inspection and one copy of the report shall be sent to Engineering department.

11. GUARANTEE:

Bidder shall stand guarantee towards design, materials, workmanship & quality of process/ manufacturing of items under the contract for due and intended performance of the same, as an integrated product delivered under this contract. In the event any defect is found by the Company up to a period of 18 months from the date of commissioning or 24 months from the date of last supplies made under the contract, whichever is earlier, supplier shall be liable to undertake to replace/rectify such defects at his own costs. within mutually agreed timeframe, and to the entire satisfaction of the Company, failing which the Company will be at liberty to get it replaced/rectified at supplier's risks and costs and recover all such expenses plus the Company's own charges (@ 20% of expenses incurred), from the supplier or from the "Security cum Performance Deposit" as the case may be.

The bidder shall further be responsible for 'free replacement' for another period of THREE years from the end of guarantee period for any 'latent defects' if noticed by the company.

12. PACKING:

Supplier shall ensure that all the material covered under this specification shall be prepared for rail/road transport and be packed in such a manner so as to protect the equipment from damage in transit. The material used for packing shall be environmentally friendly. Fittings for different sizes of conductors shall be packed in different boxes/gunny bags and shall be complete with their minor accessories fitted in place and colour codes on tags/fittings shall be marked to identify suitability for different sizes. The bidder shall provide instructions regarding handling and storage precautions to be taken at site.

13. TENDER SAMPLE:

Bidder shall submit the sample of material during submission of Bids.

TPWODL	TP WESTERN ODISHA DISTRIBUTION LTD	Page 9 of 10
DOCUMENT TITLE	SPECIFICATION FOR DISC INSULATOR HARDWARE FITTINGS (70KN, 90KN & 120KN)	EFFECTIVE DATE 13/05/2022
DOCUMENT NUMBER:	ENG-MCH-032	REVISION NO: R0

14. QUALITY CONTROL:

The bidder shall submit with the offer Quality Assurance Plan indicating the various stages of inspection, the tests and checks which will be carried out on the material of construction, components during manufacture and bought out items and fully assembled component and equipment after finishing. As part of the plan, a schedule for stage and final inspection within the parameters of the delivery schedule shall be furnished. The Purchaser's engineer or its nominated representative shall have free access to the manufacturer's/sub-supplier's works to carry out inspections. The bidder shall ensure that the material supplied is as per the Guaranteed Technical Particulars as specified in the specifications.

15. TESTING FACILITIES:

Bidder shall have adequate in-house testing facilities for carrying out all routine tests & acceptance tests as per relevant International / Indian standards.

16. MANUFACTURING ACTIVITIES:

The successful bidder will have to submit the bar chart for various manufacturing activities clearly elaborating each stage, with quantity. This bar chart should be in line with the Quality assurance plan submitted with the offer.

17. SPARES, ACCESSORIES AND TOOLS

Not applicable.

18. DRAWINGS AND DOCUMENTS

Following drawings and documents shall be submitted in line with the requirement of Tender specifications:

- Completely filled in Schedule "A" Guaranteed Technical Particulars & Schedule "B" Deviations
- Work Experience details
- Type test certificates.
- Drawing 1 set of Hard Copy & Soft copy PDF File containing complete information about manufacturing.

19. SCHEDULE- "A" GUARANTEED TECHNICAL PARTICULARS

SL. NO.	TECHNICAL PARTICULARS	To Be Furnished By The Bidders		
1	Type	B&S type		
2	Ultimate Strength	70 KN	90 KN	120 KN
3	Suitable for conductor Size			
4	Slip strength of tension clamp			

TPWODL	TP WESTERN ODISHA DISTRIBUTION LTD	Page 10 of 10
DOCUMENT TITLE	SPECIFICATION FOR DISC INSULATOR HARDWARE FITTINGS (70KN, 90KN & 120KN)	EFFECTIVE DATE 13/05/2022
DOCUMENT NUMBER:	ENG-MCH-032	REVISION NO: R0

SL. NO.	TECHNICAL PARTICULARS	To Be Furnished By The Bidders		
5	Referred IS Standard			
6	Material Used			
a)	Cross Arm			
b)	Ball Eye			
c)	Socket Eye			
d)	Bolted Type Tension Clamp and Keeper			
e)	Security Clip			
f)	Split Pin			
g)	Cotter Pin and Bolt			
h)	Nuts			
i)	Spring Washer			
j)	Plain Washer			
k)	Zn confirming to grade			
m)	Size of U Bolt			
7	Galvanizing			

20. SCHEDULE “B” DEVIATIONS:

(TO BE ENCLOSED WITH TECHNICAL BID)

All deviations from this specification shall be set out by the Bidders, clause by Clause in this schedule. Unless specifically mentioned in this Schedule, the tender shall be deemed to confirm the purchaser's specifications:

SL. No	Clause No.	Details of deviation with justifications

We confirm that there are no deviations apart from those detailed above.

Seal of the Company:

Signature

Designation

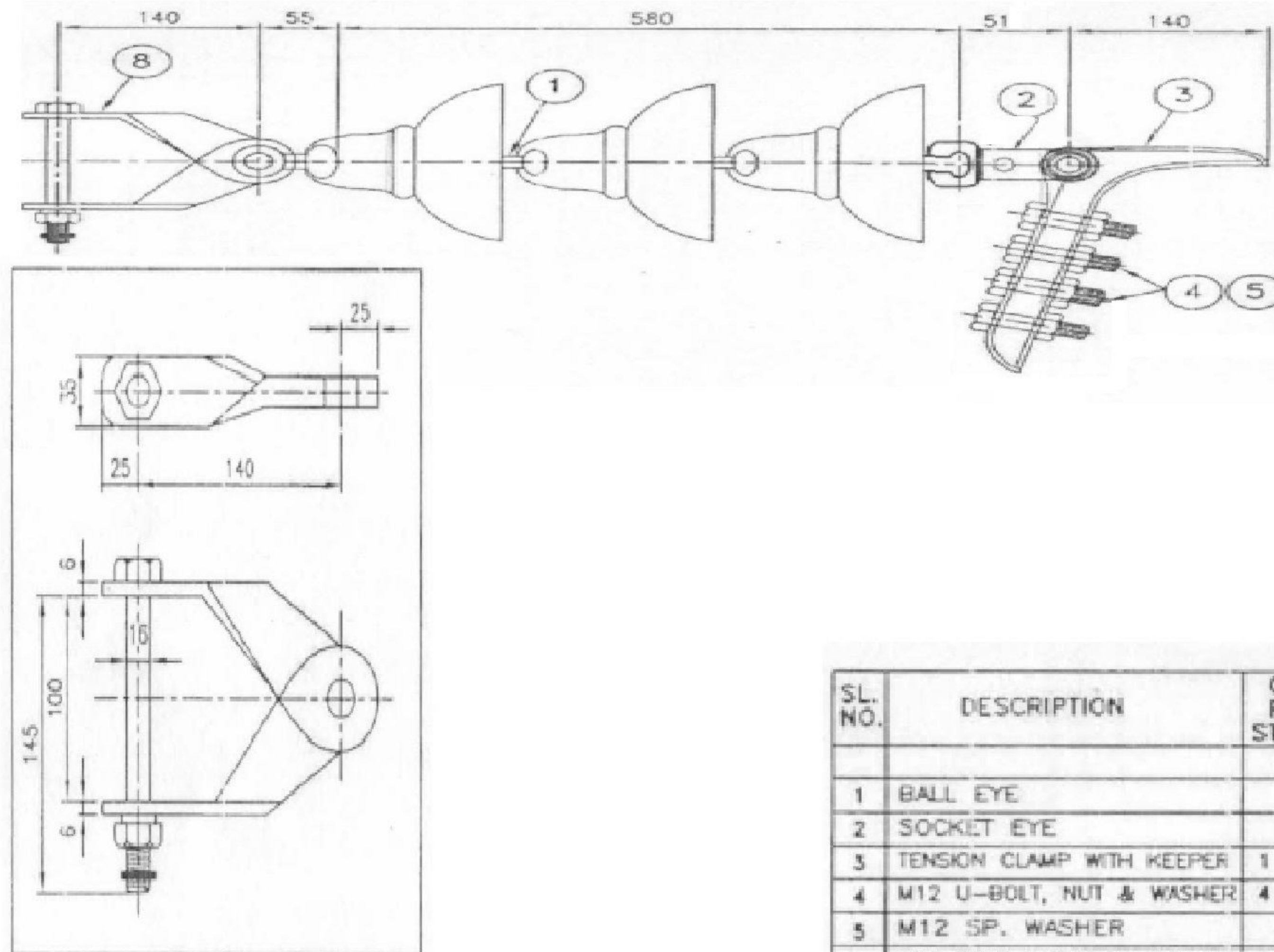
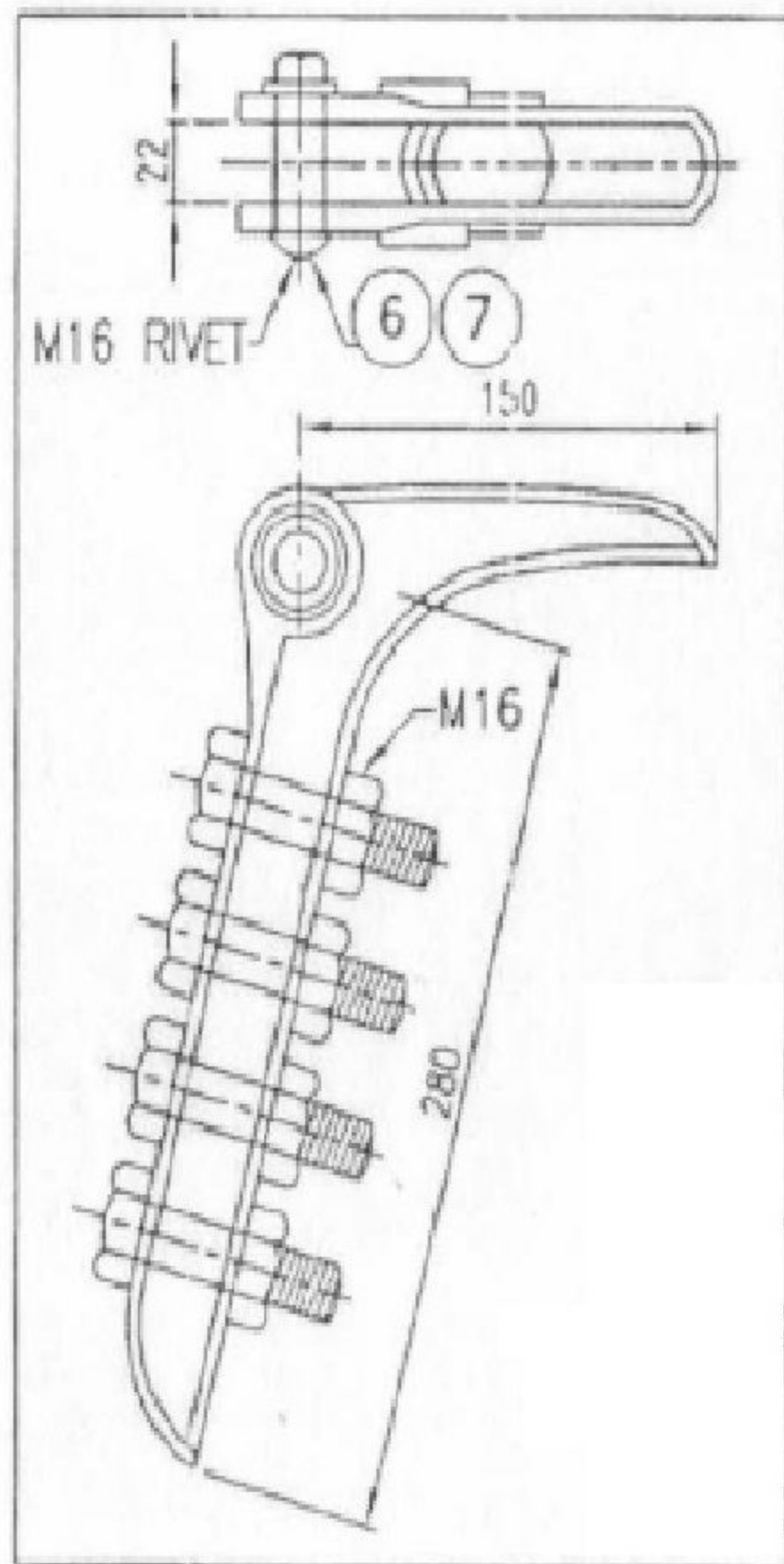

SL. NO.	DESCRIPTION	QTY. PER STRING	MATERIAL
1	BALL EYE	1	FORGED STE
2	SOCKET EYE	1	FORGED STE
3	TENSION CLAMP WITH KEEPER	1 SET	ALUMINIUM A
4	M12 U-BOLT, NUT & WASHER	4 SET	MILD STEEL
5	M12 SP. WASHER	8	SP. STEEL E
6	M16 BOLT, NUT WITH WASHER	1 SET	MILD STEEL
7	SPLIT PIN	1	STAINLESS S
8	CROSS ARM STRAP(35X6)	1 SET	MILD STEEL

TECHNICAL DATA

1. All Dimensions are in mm.
2. Tolerance : $\pm 5\%$
3. Minimum Failing Load: 120 KN
4. Item conforms to BS:-3288 (Part-1)
5. Galvanizing conforms to BS:729/ISO:146

TP WESTERN ODISHA DISTRIBUTION LIMITED

4 BOLT 120 KN DISC HARDWARE FITTINGS B&S TYPE

GCC-Supply
(Annexure to Tender Documents)

CONFIDENTIAL

**CONTENTS**

CLAUSE NO.	DESCRIPTION
1.0	ORGANIZATIONAL VALUES
2.0	ETHICS
3.0	CONTRACT PARAMETERS
3.1	Issue/Award of Contract
3.2	Contract Commencement Date
3.3	Contract Completion Date
3.4	Contract Period/ Time
3.5	Contract Execution Completion Date
3.6	Contract Price /Value
3.7	Contract Document
3.8	Contract Language
3.9	Reverse Auction
4.0	SCOPE OF WORK
5.0	PRICES/RATES/TAXES
5.1	Changes in statutory Tax Structure
6.0	TERMS OF PAYMENT
6.1	Quantity Variation
6.2	Full and Final Payment
7.0	MODE OF PAYMENT
8.0	SECURITY CUM PERFORMANCE DEPOSIT
9.0	STATUTORY COMPLIANCE
9.1	Compliance to Various Acts
9.2	SA 8000
9.3	Affirmative Action
10.0	QUALITY
10.1	Knowledge of Requirements
10.2	Material/Equipment/Works Quality
10.3	Adherence to Rules & Regulations
10.4	Specifications and Standards
11.0	INSPECTION/PARTICIPATION
11.1	Right to Carry Out Inspection
11.2	Facilitating Inspection
11.3	Third Party Nomination
11.4	Waiver of Inspections
11.5	Incorrect Inspection Call

CONTENTS	
CLAUSE NO.	DESCRIPTION
12.0	MDCC & DELIVERY OF MATERIALS
12.1	Material Dispatch Clearance Certificate
12.2	Right to Rejection on Receipt
12.3	Consignee
12.4	Submission of Mandatory Documents on Delivery
12.5	Dispatch and Delivery Instructions
13.0	GUARANTEE
13.1	Guarantee of Performance
13.2	Guarantee period
13.3	Failure in Guarantee period (GP)
13.4	Cost of repairs on failure in GP
13.5	Guarantee Period for Goods Outsourced
13.6	Latent Defect
13.7	Support beyond the Guarantee Period
14.0	LIQUIDATED DAMAGES
14.1	LD Waiver Request
15.0	UNLAWFUL ACTIVITIES
16.0	CONFIDENTIALITY
16.1	Documents
16.2	Geographical Data
16.3	Associate's Processes
16.4	Exclusions
16.5	Violation
17.0	INTELLECTUAL PROPERTY RIGHTS
18.0	INDEMNITY
19.0	LIABILITY & LIMITATIONS
19.1	Liability
19.2	Limitation of Liability
20.0	FORCE MAJEURE
21.0	SUSPENSION OF CONTRACT
21.1	Suspension for Convenience
21.2	Suspension for Breach of Contract Conditions
21.3	Compensation in lieu of Suspension
22.0	TERMINATION OF CONTRACT
22.1	Termination for Default/Breach of Contract
22.2	Termination for Convenience of Associate
22.3	Termination for Convenience of TPWODL

Doc. Title	GENERAL CONDITIONS OF CONTRACT FOR SUPPLY ORDERS	
Rev. No	0	Page 3 of 44

CONTENTS	
CLAUSE NO.	DESCRIPTION
23.0	DISPUTE RESOLUTION AND ARBITRATION
23.1	Governing Laws and jurisdiction
24.0	ATTRIBUTES OF GCC
24.1	Cancellation
24.2	Severability
24.3	Order of Priority
25.0	ERRORS AND OMISSIONS
26.0	TRANSFER OF TITLES
27.0	INSURANCE
28.0	SUGGESTIONS & FEEDBACK
29.0	CONTACT POINTS
30.0	LIST OF ANNEXURES

GENERAL CONDITIONS OF CONTRACT

Doc. Title	GENERAL CONDITIONS OF CONTRACT FOR SUPPLY ORDERS	
Rev. No	0	Page 4 of 44

1.0 ORGANIZATIONAL VALUES

The Tata Group has always been a value driven organization. These values continue to direct the Group's growth and businesses. The six core Tata Values underpinning the way we do business are:

Integrity - We must conduct our business fairly, with honesty and transparency. Everything we do must stand the test of public scrutiny.

Understanding - We must be caring, respectful, compassionate and humanitarian towards our colleagues and customers around the world and always work for the benefit of India.

Excellence - We must constantly strive to achieve the highest possible standards in our day to day work and in the quality of goods and services we provide.

Unity - We must work cohesively with our colleagues across the group and with our customers and partners around the world to build strong relationships based on tolerance, understanding and mutual co-operation.

Responsibility - We must continue to be responsible and sensitive to the countries, communities and environments in which we work, always ensuring that what comes from the people goes back to the people many times over.

Agility - We must work in a speedy and responsive manner and be proactive and innovative in our approach.

2.0 ETHICS

In our effort towards Excellence and in Management of Business Ethics at TPWODL, an Ethics Management Team is constituted.

The main objective of the Ethics Management Team is to:

1. Record, address and allay the issues and concerns on ethics raised by different stakeholders like employees, consumers, vendors, Associates etc. by initiating immediate corrective actions.
2. Ensure proper communication of the ethics policies and guidelines through prominent displays at all offices of TPWODL and through printed declarations in all concerned documents where external stakeholders are involved.
3. Ensure proper framework of policies as preventive measures against any ethics violation recorded by them.
4. Prepare and submit MIS of all issues and concerns, corrective and preventive actions on monthly basis to the top management for their information.

All Associates and Stakeholders are requested to register any grievance on ethics violation on our website www.tatapower.com

3.0 CONTRACT PARAMETERS

3.1 Issue/Award of Contract

TPWODL awards the contract to the Associate in writing in the form of Purchase Order (PO) or Rate Contract (RC), hereafter referred as Contract, through in any or all of following modes physical handover / post / e-mail / web document / fax with all the attachments/enclosures which shall be part of the contract document.

Doc. Title	GENERAL CONDITIONS OF CONTRACT FOR SUPPLY ORDERS	
Rev. No	0	Page 5 of 44

On receipt of the contract, the associate shall return to TPWODL copy of the contract document duly signed by legally authorized representative of associate, within two days of Effective Date of Contract for contracts having contract execution time less than 30 days and within five days for all other contracts.

3.2 Contract Commencement Date

The date of issue/award of contract shall be the Effective Date of Contract or Contract Commencement date.

3.3 Contract Completion Date

The date of expiry of Guarantee Period shall be deemed as the Contract Completion Date.

3.4 Contract Period/Time

The period from Contract Commencement Date to Contract Completion Date shall be deemed as the Contract Period/Time.

3.5 Contract Execution Completion Date

The stipulated date for completing the supply as per schedule of quantities shall be deemed as the Contract Execution Completion Date.

3.6 Contract Price /Value

The total all inclusive price/value mentioned in the PO/RC is the Contract Price/Value and is based on the quantity, unit rates and prices quoted and awarded and shall be subject to adjustment based on actual quantities supplied and accepted and certified by the authorized representative of the company unless otherwise specified in schedule of quantities or in contract documents.

3.7 Contract Document

The Contract Document shall mean and include but not limited to the following:

- NIT/Tender Enquiry, QR, Instruction to Bidders, Special Condition of Contract (SCC) of tender, GCC, Technical & Commercial Specifications including relevant annexure and attachments).
- Bids & Proposals Received from Associate including relevant annexure/attachments.
- RC/PO with agreed deviations from the tender/bid documents.
- All the Inspection and Test reports, Detailed Engineering Drawings.
- Material Dispatch Clearance Certificate (MDCC).
- Minutes of Meeting (MoM)

3.8 Contract Language

All documents, instructions, catalogues, brochures, pamphlets, design data, norms and calculations, drawings, operation, maintenance and safety manuals, reports, labels, on deliveries and any other data shall be in English Language.

The Contract documents and all correspondence between the TPWODL, Third Parties associated with the contract, and the Associate shall be in English language.

However, all signboards required indicating "Danger" and/or security at site and otherwise statutory required shall be in English, Hindi, and local languages.

Doc. Title	GENERAL CONDITIONS OF CONTRACT FOR SUPPLY ORDERS	
Rev. No	0	Page 6 of 44

3.9 Reverse Auction

TPWODL reserves the right to conduct the reverse auction (instead of public opening of price bids) for the products / services being asked for in the tender. The terms and conditions for such reverse auction events shall be as per the Acceptance Form attached in Annexure F. The bidders along with the tender document shall mandatorily submit a duly signed copy of the Acceptance Form as mentioned in the Annexure J as a token of acceptance for the same.

4.0 SCOPE OF WORK

All the activities that are to be undertaken by the Associate to realize the contractual deliverables in completeness form Scope of Work. Following clauses list, but not limited to, major requirements of the scope of work.

The associate shall satisfy himself and undertake fully the technical/commercial requirements of items to be supplied as listed in the Schedule of Quantities together with the tests to be performed /test reports to be furnished before dispatch, arrangement of stage and final inspections during manufacturing as per terms and conditions of contract, technical parameters & delivery terms and conditions including transit insurance to be met in order to fully meet TPWODL's requirements.

Completeness: Any supplies and services which might have not been specifically mentioned in the Contract but are necessary for the scope mentioned in Special Terms & Conditions and/or completeness of the works at the highest possible level, including any royalties, license fees & compensation to be paid, whether incurred by the associates or by a third party for the work covered in the scope, regardless of when incurred, shall be supplied/provided by the associate without any extra cost and within the time schedule for efficient , smooth and satisfactory operation and maintenance of the works at the highest possible level under Indian conditions (but according to international standards for facility of this type), unless expressly excluded from the scope of supplies and services in this Contract.

TPWODL have the right, during the performance of the Contract, to change the scope and/or technical character of the Project and/or of the supplies and services stipulated in the Contract by submitting a request in writing to the Associate. The Associate shall, within fifteen days of receipt of such request from the TPWODL, provide Purchaser with a reasonably detailed estimate of the cost of the change outlined in the request.

In the event, TPWODL requests a change, the Contract price and time shall be adjusted upwards or downwards, as the case may be and shall be mutually agreed to. The associate shall not be entitled to any extension of time unless such changes adversely affect the time schedule.

The Associate shall not proceed with the changes as requested till adjustment of contract price and time schedule where so applicable in terms of or otherwise directed by the TPWODL.

5.0 PRICES/RATES/TAXES

Unless specified elsewhere in the contract document, the prices/rates are inclusive of cost of finished product for which MDCC will be issued by TPWODL, packaging and forwarding charges, freight and transit insurance charges covering loading at Associate's works, transportation to TPWODL store/site & unloading & delivery at TPWODL stores/TPWODL site, cost of documentation including all the relevant test certificates and other supportive documents to be furnished.

Doc. Title	GENERAL CONDITIONS OF CONTRACT FOR SUPPLY ORDERS	
Rev. No	0	Page 7 of 44

The Prices/Rates are inclusive of all taxes, levies, cess and duties, particularly Goods and Services Tax as applicable. All government levy / taxes shall be paid only when the invoice is submitted according to the relevant act.

The prices/rates shall remain firm till actual completion of entire supply of goods/material/equipment as per contract is achieved and shall remain valid till the completion of the contract.

The prices shall remain unchanged irrespective of TPWODL making changes in quantum in all or any of the schedules of items of contract.

5.1 Changes in Statutory Tax Structure

If rate of any or all of the statutory taxes and duties applicable to the contract changes, such changes shall be incorporated by default if the changes occur within the contract execution time and shall be applicable if the contract is executed by the Associate within the Contract Execution Time.

For execution of contracts beyond contract execution time, where the delay is not attributable to TPWODL no upward revision in tax /duties shall be considered irrespective of changes in the statutory tax structure either within the contract execution time or beyond. However, in such cases, benefits due to any downward revisions in statutory tax rates shall be passed on to TPWODL.

6.0 TERMS OF PAYMENT

On delivery of the materials in good condition and certification of acceptance by TPWODL official, Associate shall submit the Bills/Invoices in original in the name of "TP Western Odisha Distribution Ltd" to invoice desk, complete with all required documents as under:

- Test Reports (4 sets).
- MDCC issued by TPWODL.
- Packing List.
- Drawing and Catalogue.
- Guarantee/Warrantee Card.
- Delivery Challan.
- O&M Manual.
- Copy of Order.
- Minutes of Meeting.

Bills/ invoices shall mention Supplier's GST Number. TPWODL will make 100% payment within 30 days of submission of the Bill/Invoice complete in all respects and along with all the requisite documents mentioned above, subject to condition that Associate has furnished the requisite Security-cum-Performance Guarantee as stipulated in the contract.

6.1 Quantity Variation

Payment will be made on the basis of actual quantity of supplies/actual measurement of works accepted by TPWODL and not on the basis of contract quantity.

Doc. Title	GENERAL CONDITIONS OF CONTRACT FOR SUPPLY ORDERS	
Rev. No	0	Page 8 of 44

6.2 Full and Final Payment

Full & Final Payment in all contracts shall be made subject to the associate submitting “No Demand Certificate” in the format as per Annexure-C.

7.0 MODE OF PAYMENT

Payment shall be made through crossed Cheque or RTGS whichever of the two modes chosen by the Associate, in favour of Associate’s Bank Account on TPWODL records, on whose name Contract has been issued. Those Associates opting for the RTGS mode shall submit the details of Bank Account and other details as per annexure G. Further, for any payments made, TPWODL is not responsible for any consequences/disputes Associate have among the owners channel partners, sub-Associates and all such dispute/concerns shall be settled solely by the Associate.

8.0 SECURITY CUM PERFORMANCE DEPOSIT

Associates shall submit within 15 days from the effective date of issue of PO/RC, Security Performance Bank Guarantee (SPBG) in the format as per Annexure B of this document from banks acceptable to TPWODL for:

- (a) 5% of the PO value if purchase order value is more than Rs 5 Crores.
- (b) 10% of the PO value if purchase order value is less than Rs 5 Crores.

This shall remain valid till the end of the Guarantee Period of contract, plus one month.

- (c) 5% of the RC value in case of Rate Contract. This shall remain valid till the Guarantee period plus one month.

- For PO/RC values less than Rs. 5 lacs, Associate may request for deduction of amount equivalent to SPBG value from their first invoice. Such amount shall be withheld by TPWODL while processing the invoice and shall be released after completion of Guarantee Period plus one month.
- For PO/RC values less than Rs. 3 lacs, the clause (8.0) for Security cum Performance Bank Guarantee (SPBG) shall not be applicable.
- In case of RC (Rate Contract) after the expiry of RC validity, Associate shall have to submit SPBG. However, the Associate has the option to re-submit the SPBG as per actual RO (Release Order) value issued against the RC, valid for Guarantee Period plus one month. The Guarantee Period shall be considered as per the last RO issued against the said RC. The original SPBG as submitted against the RC shall be released on submission of the new SPBG to TPWODL. Alternatively, Associate may extend the validity of original SPBG only till the requisite period, i.e. Guarantee Period plus one month.

9.0 STATUTORY COMPLIANCE

9.1 Compliance to Various Acts

Associate should ensure adherence to all applicable laws, rules and regulation applicable under this contract from time to time. In case of violation any risk, costs etc shall be in associates account and keep TPWODL indemnified always till completion of contracts.

Doc. Title	GENERAL CONDITIONS OF CONTRACT FOR SUPPLY ORDERS	
Rev. No	0	Page 9 of 44

9.2 SA 8000

As TPWODL is SA 8000 compliant, it expects its Associates to follow guidelines of SA 8000:2014 on the following aspects

1. Child Labour
2. Forced or Compulsory Labour
3. Health & Safety
4. Freedom of Association & Right to Collective Bargaining
5. Discrimination
6. Disciplinary Practices
7. Working Hours
8. Remuneration
9. Management System

9.3 Affirmative Action

TPWODL appreciate and welcome the engagement/employment of persons from SC/ST community or any other deprived section of society by their business associates.

Relaxation in Contract Clauses under Affirmative Action for SC/ ST Business Associates**

TPWODL believes that inclusive growth is the key to sustainable development, and to promote the same Policy on Affirmative Action for Scheduled Caste & Scheduled Tribe Communities has been adopted across the company.

Under the same pre-text, and to promote entrepreneurship among SC/ST community TPWODL has taken initiative by proposing relaxations in contract clauses as per below:

S. No	Initiative	for SC/ ST BA's	Guideline Document
1	Tender Fees	100% waiver for SC/ST community	All Open Tenders
2	Earnest Money Deposit	50 % relaxation of estimated EMD value	All limited and Open Tenders
3	Performance Bank Guarantee	50% relaxation in PBG for order value above 50 lacs else 25% relaxation	All limited and Open tenders
4	Turnover	25% relaxation in company turnover under qualifying requirement criteria	All Open Tenders

**Classification of BAs under SC/ST shall be governed under following guidelines:

- Proprietorship/ Single Ownership Firm: Proprietor of the firm should be from SC/ST community. Governing document shall be duly audited balance Sheet for the last FY bearing the name of proprietor.
- Partnership Firm: Only such firms shall qualify which have SC/ST partners holding equal to or more than 50% of the total ownership pattern of the firm. Governing document shall be Partnership Deed and audited balance sheet/ ITR for last FY.
- Private limited company: Only such firms shall qualify which have SC/ST directors holding equal to or more than 50% of the total ownership pattern of the firm. Governing

Doc. Title	GENERAL CONDITIONS OF CONTRACT FOR SUPPLY ORDERS	
Rev. No	0	Page 10 of 44

document shall be Memorandum of Understanding (MoU) and/or Article of Association (AoA).

Governing document shall be Memorandum of Understanding (MoU) and/or Article of Association (AoA).

Note: Certification from SC/ST commission shall be required for deciding upon SC/ST status of a person.

10.0 QUALITY

10.1 Knowledge of Requirements

The Associate shall be deemed to have carefully examined and to have knowledge of the equipment, the general and other conditions, specifications, schedules, drawings, etc. forming part of the Contract and also to have satisfied himself as to the nature and character of the work to be executed and the type of the equipment and duties required including wherever necessary of the site conditions and relevant matters and details. Any information thus procured or otherwise obtained from TPWODL/Consultants shall not in any way relieve the Associate from his responsibility and executing the works in accordance with the terms of contract.

10.2 Material/Equipment/Works Quality

The items / works under the scope of the Associate shall be of the best quality and workmanship according to the latest engineering practice and shall be manufactured from materials of best quality considering strength and durability for their best performance and, in any case, in accordance with the specifications set forth in this Contract. All material shall be new. Substitution of specified material or variation from the process of fabrication/ construction/ manufacture may be permitted but only with the prior written approval of the TPWODL.

10.3 Adherence to Rules & Regulations

The Associate shall procure and/or fabricate/erect all materials and equipment in accordance with all requirements of Central and State enactment, rules and regulations governing such work in India and at site. This shall not be construed as relieving the Associate from complying with any requirement of TPWODL as enumerated in the Contract which may be more rigid than and not contrary to the above mentioned rules, nor providing such construction as may be required by the above mentioned rules and regulations. In case of variance of the Technical Specification from the laws, ordinance, rules and regulations governing the work, the Associate shall immediately notify the same to the TPWODL. It is the sole responsibility of the Associate, however, to determine that such variance exists. Wherever required by rules and regulations, the Associate shall also obtain the statutory authorities' approval for the plant, machinery and equipment to be supplied by the Associate.

10.4 Specifications and Standards

The Associate shall follow all codes and standards referred in the Contract Document. Codes and standards of other may be followed by the Associate with the prior written approval of TPWODL, provided materials, supplies and equipment according to the standard are equal to or better than the corresponding standards specified in the Contract.

Brand names mentioned in the Contract documents are for the purpose of establishing the type and quality of products to be used. The Associate shall not change the brand name and

Doc. Title	GENERAL CONDITIONS OF CONTRACT FOR SUPPLY ORDERS	
Rev. No	0	Page 11 of 44

qualities of the bought out items without the prior written approval of the TPWODL. All such products and equipment shall be used or installed in strict accordance with original manufacturer's recommendations, unless otherwise directed by the TPWODL. In any circumstances the codes, specimen and standards prescribed by any government agency should not be violated.

11.0 INSPECTION/PARTICIPATION

11.1 Right to Carry Out Inspection

TPWODL reserves the right to send its representatives for inspection or participation at various stages of contract execution listed below, applicable as per contract construction.

- During basic design and detail engineering of material/ Equipment carried out by Associate /Outsourced Agencies.
- During manufacturing stages of the product at Associate's/Associate's Outsourced Agency's Plant/Facility.
- During Pre-dispatch Inspection and Testing of finished/manufactured product at Associate's/Associate's outsourced Agency's Plant/Facility.
- During Installation & Commissioning Activities/Stages.
- Prior to Clearing of the completed installation for commissioning.
- Any other stage as find appropriate by TPWODL during contract execution time.

All inspections and participations shall be carried out by TPWODL giving written intimation to the Associate or receiving appropriate advance written inspection call from the Associate, unless otherwise specified elsewhere in the contract document.

11.2 Facilitating Inspection

The Associate shall provide all opportunities and information to TPWODL's engineers to get acquainted with the technical know-how and the methods and practices adopted by the Associate in basic and detail engineering. The Associate shall provide documents, drawings, calculations etc. as may be required by TPWODL's Engineers.

The Associate shall provide free of charge office accommodation, office facilities, secretarial services, communication facilities, general and drawing office stationary, etc. as may be reasonably required by the TPWODL's engineers. Similarly, facilities shall also be provided by Associate's outsource agencies/partners/authorized dealers (collectively termed as sub associates) if such basic and detail engineering activities are carried out in the design offices of sub-Associates.

The Associate shall be responsible for the safety of employees of TPWODL/Third Party Agency when they are at the Associate's /Associate's outsource agency's plant or facility for carrying out/witnessing inspection/testing. All statutory safety precautions as applicable shall be followed by the Associate during Inspection Testing. If TPWODL inspectors are not satisfied with the safety arrangements at the plant, TPWODL have the right to call off inspection till such time corrective action is taken by the Associate.

Before raising the call for pre-dispatch final inspection and testing, the Associate shall conduct all the tests—type tests, routine tests etc-as specified in the contract document and submit copies of the test certificates to TPWODL along with the inspection call, for scrutiny of TPWODL.

Doc. Title	GENERAL CONDITIONS OF CONTRACT FOR SUPPLY ORDERS	
Rev. No	0	Page 12 of 44

The Associate and TPWODL shall jointly document all the observations, comments and action points after completion of inspection and it shall be binding on the Associate to provide compliance on all the points requiring compliance and furnish the compliance report to the designated authority of TPWODL for receiving clearance for dispatch of materials

11.3 Third Party Nomination

TPWODL also may nominate a third party for the purpose of carrying out the inspection and such an agency shall be entitled to all the rights and privileges of TPWODL as far as conducting the inspection.

11.4 Waiver of Inspections

TPWODL on its own discretion shall chose to waive off any inspection and ask the Associate to submit all the test reports as applicable as per contract specifications, related to inspection and testing of the goods ordered for scrutiny and clearance for dispatch.

11.5 Incorrect Inspection Call

In case it is observed that the material offered for inspection is not ready at the time of TPWODL inspection visit rendering it as futile, all costs towards such inspection shall be recovered from the BA. Taxes as applicable on such recoveries shall be borne by the BA.

12.0 MDCC & DELIVERY OF MATERIALS

12.1 Material Dispatch Clearance Certificate

Associate shall deliver material/goods/equipment against Supply Contracts or Supply Part of Composite/Service Contracts only after receiving Material Dispatch Clearance Certificate (hereafter termed as MDCC) issued by designated authority of TPWODL. Material delivered at TPWODL stores or at project site without a valid MDCC issued by the designated official of TPWODL shall be rejected. MDCC shall be issued to associate furnishing compliance report on the action points documented during pre-dispatch inspection and testing at Associate's/ Sub Associate's plant/ facility. In case Pre-dispatch inspection is waived at the discretion of TPWODL, then, MDCC shall be issued on receiving all the test reports-routine& type-from the Associate and finding them in order.

The associate shall include and provide for securely protecting and packing the materials so as to avoid loss or damage during handling and transport by air, sea, rail and road or any other means.

All such packing shall allow to the extent possible for easy removal and checking at Site. The associate shall take special precautions to prevent rusting of steel and iron parts during transit by sea. Gas seals or other materials shall be utilized by the associate for protection against moisture during transit of all Plant and Equipment.

Each Equipment or parts of Equipment shall be tagged with reference to the assembly drawings and corresponding part numbers. Each bale or package shall contain a packing note quoting specifically the name of the associate, item description, quantity, item / package identification.

All packing cases, containers, packing and other similar materials shall be new and supplied free by the associate and it shall not be required to be returned to the associate.

Notwithstanding anything stated in this clause, the associate shall be entirely responsible for loss, damage or depreciation or deterioration to the materials and supplies due to faulty and/or insecure packing or otherwise during transportation to the Site until otherwise provided herein.

Doc. Title	GENERAL CONDITIONS OF CONTRACT FOR SUPPLY ORDERS	
Rev. No	0	Page 13 of 44

In case of the consignments dispatched by road, the associate shall ensure that it or its subcontractors:

- i) Identify and obtain the correct type of trucks/trailers, keeping in view the nature of consignments to be dispatched.
- ii) Take such actions as may be necessary to avoid all possible chances of damages during transit and to ensure that all packages are firmly secured.

Timelines for inspection and MDCC is as below:

S. No.	Inspection	MDCC issuance time including Inspection time (max.)
1	Outside Sambalpur	12 days
2	Within Sambalpur	5 days
3	Waiver*	3 working days

* Associate is expected to raise the inspection call assuming that Inspection shall be carried out by TPWODL. The decision for waiver of inspection shall be on sole discretion of TPWODL.

12.2 Right to Rejection on Receipt

Goods/Material/Equipment delivered in condition physically damaged & incomplete as a product ordered, or not packed and transported as per the terms and conditions of the contract is liable to be rejected. Such item shall be lifted back by Associates within 15 days from receipt of rejection note from TPWODL and have to supply back the material within next 30 days or within the timeframe mutually decided by Associate and TPWODL.

If delivery of the material is beyond the agreed time, Liquidated damage clause, mentioned in this GCC separately shall be applicable; but the period for levy of LD shall be considered as per the original delivery schedule and not from the agreed timelines for material rectification.

12.3 Consignee

Unless otherwise specified in the Contract Document, Materials/Goods/Equipment shall be consigned to "Stores-In-Charge", TPWODL, Burla.

12.4 Submission of mandatory documents on Delivery

Following documents shall be mandatorily submitted by BA along with supply of material to TPWODL stores/site:

S. No.	Documents	Requisite
1	Invoice copy in original	With all consignments
2	LR copy	Wherever required
3	Packing list	With all consignments
4	MDCC	With all consignments
5	Purchase order / Release order	Signed copy
6	Test certificates	With all consignments
7	Inspection/JVR report	In case pre-dispatch inspection is conducted
8	Device data in CD as per template for metering items	Wherever applicable

12.5 Dispatch and Delivery Instructions

S. No.	Instructions
1	Purchase order/ Release order no. shall be mentioned on invoice and on material
2	TPWODL material code and material description shall be mentioned in invoice and on material.
3	"Property of TPWODL" shall be embossed on material.
4	The material shall be properly sealed and packed in standard packing as per purchase order terms & conditions.
5	The weight and quantity of material shall be mentioned wherever applicable
6	The material supplied shall be co-related with the packing list.
7	The name plate detail on equipment shall include Material code, Material description, specification detail of material [as applicable], Serial No. Year of manufacturing, PO/RO no. and date, "PROPERTY OF TPWODL, Burla", Guarantee period and Associate's name.
8	In case of manual unloading, supplier / transporter shall deploy sufficient Labour for unloading the material at TPWODL central store. For heavy item(s), crane will be provided by TPWODL [unloading cost will be recovered from the associate].
9	The driver should have valid License and one helper in truck. All the documents of truck like registration papers, PUC etc. should be available in Truck.
10	BA representative should accompany the material and get it unloaded / stacked in his presence wherever possible.

13.0 GUARANTEE

13.1 Guarantee of Performance

Associates shall stand guarantee that the equipment and material supplied under the contract is free from design, manufacturing, material, construction, erection & installation and workmanship & quality defects and is capable of its due, rated and intended quality performance, as an integrated product delivered under the contract, for a specific period termed as Guarantee Period(as elaborated elsewhere in this clause). The Associate should also guarantee that the equipment/material is new and unused except for the usage required for the tests and checks required as part of quality assurance.

13.2 Guarantee Period

The Guarantee Period will be equipment/service/work specific and shall be as specified in the Standard Specifications of TPWODL for the equipment/material/service/work and where standard specifications are not part of contract documents or guarantee period is not specified in the standard specifications,, the guarantee period shall be as per the Special Terms and Conditions of the Contract. In case of no mention of the guarantee period in standard specifications or SCC Guarantee Period will be 12 Months from the Date of Commissioning or 24 months from the date of delivery of final lot of supplies made, whichever is earlier.

13.3 Failure in Guarantee Period (GP)

If the equipment and material supplied under the contract fails to perform its due, rated & intended quality performance, during the Guarantee period, the associate is liable to undertake repair/rectify/replace the equipment and material supplied within time frame specified in the SCC or elsewhere in the contract documents at associate's cost to make the equipment and material supplied/service or work rendered under the contract of performing its due, rated and

Doc. Title	GENERAL CONDITIONS OF CONTRACT FOR SUPPLY ORDERS	
Rev. No	0	Page 15 of 44

intended quality performance. If Associate fails to repair/rectify/replace the equipment or material supplied rendered under the contract, failed in Guarantee Period, TPWODL will be at liberty to get the same done at Associate's risks and costs and recover all such expenses plus the TPWODL's own charges (@ 20% of expenses incurred), from the Associate or from the "Security cum Performance Deposit" as the case may be.

If during the Warranty/ Guarantee period some parts of the supplies are replaced owing to the defects/ damages under the Warranty, the Warranty period for such replaced parts shall be until the expiry of twelve months from the date of such replacement or renewal or until the end of original Guarantee period, whichever is later.

Any repairs during the Guarantee Period shall be carried out by the Associate within 30 days of reporting the issue to Associate by TPWODL. However, if replacement of the Equipment is required, Associate shall notify the same to TPWODL within 7 days of reporting the issue by TPWODL. Thereafter, the total time for supply of new equipment/ material shall be equal to the original delivery period of that equipment/ material as specified in the Contract. In case the Associate is not able to rectify/ replace the faulty equipment/ material within the stipulated timelines as mentioned above, penalty shall be levied as per the Liquidated Damages clause mentioned in this document. The penalty amount shall be recovered from the payment due to the vendor or by encashment of the SPBG as the case may be.

13.4 Cost of repairs on failure in GP

The cost of repairs/rectification/replacement, required transportation, site inspection /mobilization/dismantling and re-installation costs as applicable, to be borne by Associate. The Associate has to ensure that the interruption in the usage of intended purpose of the equipment is minimized to the maximum extent. In lieu of the time taken for repairs/rectification/replacement.

13.5 Guarantee period for Goods Outsourced

If the Associate outsources partly equipment/materials/services from third party as mutually agreed upon at the pre award stage of contract, TPWODL shall have the benefit of any additional guarantee period if provided by the third party for the part supplied/executed by them.

13.6 Latent Defect

Hidden defects in manufacturing or design of the product supplied and which could not be identified by the tests conducted but later manifested during operation of the equipment are termed as latent defects. Associates shall further be responsible for 'free replacement' for another period of THREE years from the end of the guarantee period for any 'Latent Defects' if noticed and reported by the Company.

13.7 Support beyond the Guarantee Period

The Associate shall ensure availability of spares and necessary support for a period of atleast 10 years post completion of guarantee period of equipment supplied against the contract.

14.0 LIQUIDATED DAMAGES

- a) For supplies which are of standalone use, multiple in quantities and having a single final delivery schedule, Liquidated damages shall be levied without prejudice to any of the other contractual rights of TPWODL, as described below:

Doc. Title	GENERAL CONDITIONS OF CONTRACT FOR SUPPLY ORDERS	
Rev. No	0	Page 16 of 44

For delay of each week and part thereof from the delivery schedule specified in the contract, 1% of contract value corresponding to undelivered quantity, provided full quantity is supplied within 130% of the original contract time. If full contractual quantity is not delivered within 130% of contract time for delivery, TPWODL has the right to levy LD on the entire contract value, subject to a maximum of 10% of the total contract value.

- b) For Supplies having phased delivery schedule as per contract terms, standalone use and multiple in quantities, Liquidated damages shall be levied without prejudice to any of the other contractual rights of TPWODL, as described below:

For the purpose of calculating and applying LD, each delivery lot shall be considered separately. For delay of each week and part thereof, from the delivery schedule specified for the lot, 1% of the contract value corresponding to the undelivered quantity of the lot subject to a maximum of 10% of the total contract value of the subject lot. However, if full contractual quantity is not delivered within 130% of contract time for delivery, TPWODL has the right to levy LD on the entire contract value, subject to a maximum of 10% of the total contract value. Deduction of LD shall be on landed cost i.e contract value inclusive of taxes and in pursuant statutory compliance GST would be applicable at the stipulated rate and the same shall be borne by Business Associate. In case of LD deduction, a GST invoice shall be issued by TPWODL as a proof of deduction/ recovery.

14.1 LD Waiver Request

Any request of LD waiver shall be submitted within thirty (30) days of deducting LD. Request submitted beyond the timeline shall not be entertained.

15.0 UNLAWFUL ACTIVITIES

The Associate shall have to ensure that none of its employees are engaged in any unlawful activities (whether covered under the scope of the present GCC or not) subversive of the TPWODL's interest failing which appropriate action (legal or otherwise) may be taken against the Associate by the TPWODL, in accordance with the terms of the present GCC.

16.0 CONFIDENTIALITY

Associate and its employees or representatives thereof shall strictly maintain the confidentiality of various information they come across while executing the contract as detailed below.

16.1 Documents

All maps, plans, drawings, specifications, schemes and other documents or information related to the Contract/Project and the subject matter contained therein and all other information given to the Associate by the TPWODL in connection with the performance of the contract shall be held confidential by the Associate and shall remain the property of the TPWODL and shall not be used or disclosed to third parties by the Associate for any purpose other than for which they have been supplied or prepared. The Associate may disclose to third parties, upon execution of confidentiality agreements, such part of the drawings, specifications or information if such disclosure is necessary for the performance of the Work provided such third parties agree in writing to keep such information confidential to the same extent and degree as provided herein, for the benefit of the TPWODL.

16.2 Geographical Data

Maps, layouts and photographs of the unit/plant including its surrounding regions showing vital installation for national security of country or those of TPWODL shall not be published or

Doc. Title	GENERAL CONDITIONS OF CONTRACT FOR SUPPLY ORDERS	
Rev. No	0	Page 17 of 44

disclosed to the third parties or taken out of the country without prior written approval of the TPWODL and upon execution of confidentiality agreements satisfactory to the TPWODL with such third parties prior to disclosure.

16.3 Associate's Processes

Title to secret processes if any developed by the Associate on an exclusive basis and employed in the design of the equipment shall remain with the Associate. TPWODL shall hold in confidence such processes and shall not disclose such processes to the third parties without prior approval of the Associate and execution by such third parties of secrecy agreements satisfactory to the Associate prior to disclosure. Upon completion of contract, such processes shall become the property of the TPWODL. Title to technical specifications, drawings, flow sheets, norms, calculations, diagrams, interpretations of test results, schematics, layouts and such other information, which the Associate has supplied to the TPWODL under the Contract shall be passed on to the TPWODL. The TPWODL shall have the right to use these for construction, erection, start-up, Trial Run, operation, maintenance, modifications and/or expansion of the works including for the manufacture of spare parts.

16.4 Exclusions

The provision of Clauses 16.1 to 16.3 shall not apply to information:

- Which at the time of disclosure are in the public domain which later on become part of public domain through no fault of the party concerned, or
- Which were in the possession of the party concerned prior to disclosure to him by the other party, or
- Which were received by the party concerned after the time of disclosure without restriction on disclosure or use, from a third party who did not acquire such information directly or indirectly from the other party or has no obligation of confidentiality for such information.

16.5 Violation

In case of violation of this clause, the Associate is liable to pay compensation and damages as may be determined by the competent authority of TPWODL.

17.0 INTELLECTUAL PROPERTY RIGHTS

If, in the course of performance of its functions and duties as envisaged by the scope of the present GCC, the Associate acquires or develops, any unique knowledge or information which would be covered, or, is likely to be covered within the definition of a trademark, copyright, patent, business secret, geographical indication or any other form of intellectual property right, it shall be obliged, under the terms of this present GCC, to share such knowledge or information with the TPWODL. All rights, with respect to, or arising from such intellectual property, as afore mentioned, shall solely vest in TPWODL.

Moreover, the Associate undertakes not to breach any intellectual property right vesting in a third party/parties, whether by breach of statutory provision, passing off, or otherwise. In the event of any such breach, the Associate shall be wholly liable to compensate, indemnify or make good any loss suffered by such third party/parties, or any compensation/damages arising from any legal proceeding/s, or otherwise. No liability of TPWODL shall arise in this respect, and any costs, damages, expenses, compensation payable by TPWODL in this regard to a third party/parties, arising from a legal proceeding/s or otherwise, shall be recoverable from the Associate.

Doc. Title	GENERAL CONDITIONS OF CONTRACT FOR SUPPLY ORDERS	
Rev. No	0	Page 18 of 44

18.0 INDEMNITY

The Associate shall at all times indemnify, keep indemnified and hold harmless the TPWODL and its officers, directors, employees, affiliates, agents, successors and assigns against all actions, claims, demands, costs, charges and expenses arising from or incurred by reason of any infringement of patent, trade mark, registered design, copy rights and/or industrial property rights by manufacture, sale or use of the equipment supplied by the Associate whether or not the TPWODL is held liable for by any court judgement. In this connection, the TPWODL shall pass on all claims made against him to the Associate for settlement.

The Associate assumes responsibility for and shall indemnify and save harmless the TPWODL from all liability, claims, costs, expenses, taxes and assessments including penalties, punitive damages, attorney's fees and court costs which are or may be required to be paid by the TPWODL and its officers, directors, employees, affiliates, agents, successors and assigns arising from any breach of the Associate's obligations under the Contract or for which the Associate has assumed responsibilities under the Contract including those imposed under any local or national law or laws, or in respect to all salaries, wages or other compensation for all persons employed by the Associate or his Sub-Associates or suppliers in connection with the performance of any work covered by the Contract. The Associate shall execute, deliver and shall cause his Sub-Associate and suppliers to execute and deliver, such other further instruments and to comply with all the requirements of such laws and regulation as may be necessary there under to conform and effectuate the Contract and to protect the TPWODL.

The TPWODL shall not be held responsible for any accident or damages incurred or claims arising, due to the Associate's error there from prior to completion of work. The Associate shall be liable for such accidents and after completion of work for such accidents as the case may be due to negligence on his part to carry out Work in accordance with Indian laws and regulations and the specifications set forth herein.

19.0 LIABILITY & LIMITATIONS

19.1 Liability

Except for any specific liability which may be identified in the Contract and which may be payable hereunder, Associate shall not be liable for any special, incidental, indirect, or consequential Damages or any loss of business Contracts, revenues or other financial loss (or equivalents thereof no matter how claimed, computed or characterized) arising out of or in connection with the Performance of the Work or supply of Goods **unless caused by Associate's negligence, willful misconduct or breach of contract.**

If the Associate is a joint venture or consortium, all concerned parties shall be jointly and severally bound to the TPWODL for the fulfillment of the provisions of the Contract. The consortium or the joint venture shall designate one party as their leader, who will be the coordinator between the parties and TPWODL. The constituents & leader of the consortium or joint venture shall not be changed without the prior consent of TPWODL.

TPWODL shall have no liability or any special, incidental, indirect or consequential Damages for any loss of Business Contracts, revenues or other financial loss arising out of this Contract.

19.2 Limitation of Liability

The total liability of Associate against any contract shall be limited to the Total All Inclusive Contract Value.

Doc. Title	GENERAL CONDITIONS OF CONTRACT FOR SUPPLY ORDERS	
Rev. No	0	Page 19 of 44

20.0 FORCE MAJEURE

Force Majeure applies if the performance by either Party ("the Affected Party") of its obligations under Contract is materially and adversely affected.

"Force Majeure" shall mean any event or circumstance or combination of events or circumstances referred below and their consequences that wholly or partly prevents or unavoidably delays any Party in the performance of its obligations under this Agreement, but only and to the extent that such events and circumstances are not within the reasonable control, directly or indirectly, of the Affected Party and could not have been avoided even if the Affected Party had taken reasonable care:

- Act of war (whether declared or undeclared), invasion, armed conflict or act of foreign enemy, embargo, blockade, revolution, riot, bombs, religious strife or civil commotion, etc. ▪ Politically motivated sabotage, or terrorism, etc.
- Action or Act of Government or Governmental agency for which remedy is beyond the control of the affected parties. ▪ Any act of God.

Note: Causes like power breakdown/ shortages/fire/strikes, accidents etc do not fall under Force Majeure.

Time being the essence of the Contract, if either party is prevented from the performance of its obligations in whole or in part due to an event of Force Majeure, then provided Notice of happening of any event by the Affected Party is given to the other party within seven (7) days from the date of occurrence of such event, which DIRECTLY has impact on works and submitted details and quantum of resulting effect, but at the same time had made all possible efforts to mitigate and overcome effects thereof, the Affected Party's performance under this Contract shall be suspended until such event ceases and the Scheduled Completion shall be delayed accordingly.

If Force Majeure event(s) continue for a period of more than three months, the parties shall hold consultation to discuss the further course of action.

Neither party shall be considered to be in default or in breach of its obligation under the Contract to the extent that performance of such obligation by either party is prevented by any circumstances of Force Majeure which arise after effective date of Contract.

Neither party can claim any compensation from the other party on account of Force Majeure.

21.0 SUSPENSION OF CONTRACT

21.1 Suspension for Convenience

TPWODL may, at any time and at its sole option, suspend execution of all or any portions of the schedule of items of contract to be supplied/work to be executed by Associate under the contract by providing to the Associate at least two business days written notice for contracts having contract completion period less than sixty days and at least seven business days' notice for all other contracts.

Upon receipt of any such notice, the Associate shall respond as follows as applicable as per contract construction.

- Immediately discontinue further supply of material/goods specified in the suspension notice for supply contracts

Doc. Title	GENERAL CONDITIONS OF CONTRACT FOR SUPPLY ORDERS	
Rev. No	0	Page 20 of 44

- Immediately discontinue further service/work and supply of materials of those services/materials/work specified in the suspension notice for service /composite contract
- Promptly make every reasonable effort to obtain suspension, upon terms satisfactory to TPWODL, of all orders, outsourcing arrangements, and rental Contracts to the extent that they relate to performance of the portion of Work suspended by the notice.
- Protect and maintain the portion of the service/Work already completed, including the portion of the Work suspended hereunder, unless otherwise specifically stated in the notice.
- Continue delivering/carrying out the supply/service/work items as per contract conditions, which do not fall under purview of the suspension notice.

On receipt of resumption notice from TPWODL, the Associate shall resume execution of contract as specified in the resumption notice, within the time frame specified in the resumption notice.

21.2 Suspension for Breach of Contract conditions.

TPWODL shall suspend execution of whole/or part thereof the contract till such time Associate complies with the conditions stipulated under section clause 22.1 for breach/default of contract conditions.

21.3 Compensation in lieu of Suspension

If the suspension of the contract in whole or in part is for convenience of TPWODL and not due to any breach of contract conditions by the associate, TPWODL at its discretion shall consider compensating all reasonable additional costs incurred by Associate in lieu of suspension of whole or part of contract, on representation of the Associate providing justified estimates of such additional costs and such estimates are found acceptable and approved by competent authority of TPWODL.

If the suspension of contract in whole or part thereof is due to breach of contract conditions (refer clause 22.1) by the Associate, Associate shall not be entitled for any compensation for any cost incurred in lieu of suspension of whole or part of contract and also shall be liable for compensating all the losses arising to TPWODL in lieu of suspension of contract. Resumption notice shall be subject to the Associate taking corrective action for the breach of contract conditions within the time frame and as per the terms specified in the suspension notice.

22 TERMINATION OF CONTRACT

22.1 Termination for Default/Breach of Contract

The contract / PO /RC shall be subject to termination by TPWODL in case of breach of the contract by the Associate which shall include but not be limited to the following:

- a. Withdrawal or intimation by the Associate of its intent to withdraw or surrender the execution / completion of the contracted work /PO or failure in ensuring adherence to any delivery schedules, in deviation of the contract/PO.
- b. Refusal or neglect on the part of the Associate to supply material/equipment of quantity or quality as specified by TPWODL and within the timeframe as specified in the contract document or refusal or neglect to execute the services/work in terms of the agreed standards of quantity or quality and/or within the timeframe specified in the contract/PO.

Doc. Title	GENERAL CONDITIONS OF CONTRACT FOR SUPPLY ORDERS	
Rev. No	0	Page 21 of 44

- c. Failure in any respect to perform any portion of the Work contracted with promptness, diligence, or in accordance with the terms of the contract.
- d. Failure to furnish guarantees as specified and /or failure to comply with the terms thereof.
- e. Failure to furnish such relevant documents or information within the time specified which may be necessary for due execution / completion of the works and documentation.
- f. Liquidation, bankruptcy either voluntary or involuntary OR entering into any composition or compromise with its creditors, or Insolvency.
- g. In case any reasonable information has been received by TPWODL that Associate has adopted/ or attempted to adopt any unethical conduct, action in award of the contract /PO or at any time thereafter.
- h. Failure to comply with applicable statutory provisions as contained in the contract or failure to comply with the applicable laws.
- i. Failure to comply with safety regulations/clauses stipulated in the contract or as may be generally instructed by TPWODL.

If the default or breach as specified under clause 22 (except sub clause g thereof) be committed by the associate for the first time, TPWODL shall issue, along with notice of default or breach, a warning notice instructing the associate to take remedial/corrective action within the time frame stipulated in the warning notice and not to repeat the same in future. The timeframe for corrective action by the associate shall be specific to the nature of breach of contract and the same shall not be objected to by the Associate. If the Associate fails to comply with the instructions in the warning notice or in taking corrective action to the satisfaction of TPWODL then TPWODL may terminate the entire or part of contract at its discretion by issuing termination notice without incurring any liability on this ground.

In case the contract is terminated for any breach of the nature specified in clause 22 g stated above, TPWODL shall have the right to terminate all the contracts TPWODL is having with the Associate by issuing termination notice which shall be without prejudice to the other rights of TPWODL available to it under law.

Without prejudice to its right to terminate for breach of contract, TPWODL may, without assigning any reason, terminate the Contract in whole or in part at any time at its discretion while the contract is in force by serving a written notice of two weeks to the Associate.

In the event of TPWODL having proceeded with termination of the contract the associate shall comply and proceed further in the following manner:

- a) Associate shall discontinue the supply, on the expiry of the said period of two weeks.
- b) Associate shall ensure that no further steps are being taken towards discharge of the obligations, terms and conditions as contained in the contract/PO. This shall include initiation of actions not limited to discontinuation of other allied and associated arrangements which the associate might have entered into with third parties for due discharge of its obligations under the contract with TPWODL.
- c) The Associate shall perform thereafter such tasks as may be necessary to preserve and protect the terminated portion of the material/service/work in progress and the materials and equipment at TPWODL sites or in transit thereto. However the associate shall continue to fulfill its contractual obligations with regard to the part of contract not terminated.

Doc. Title	GENERAL CONDITIONS OF CONTRACT FOR SUPPLY ORDERS	
Rev. No	0	Page 22 of 44

- d) It shall be open for TPWODL to conduct a joint assessment with the associate of the material, supplies, equipment ,works or in general as to the subject matter of the contract in regard to which the associate claims having completed its obligations before or during such termination.
- e) It shall be open to TPWODL to seek invocation of the performance bank guarantee or any other guarantee or other security deposit by whatever name called submitted by the associate, which shall not be objected to or protested against by the associate.

In case of termination of the contract the parties agree to be governed inter alia by the following:

- a) In case TPWODL exercises its right of termination as stated above the associate shall not dispute or object to the same.
- b) The Associate shall be entitled to receive and claim only such payments OR sums of money from TPWODL as may be found payable to it in regard to works executed by it under the terms of the contract and no other claim of any nature whatsoever shall be made by the Associate.
- c) All such provisions which the parties have agreed to survive and prevail even after termination of the contract shall remain effective despite the termination.

In the event of such termination, TPWODL may finish the Work by whatever method it may deem expedient, including the hiring of services and /or purchase of material equipment from such third parties as TPWODL may deem fit or may itself provide any labor or materials and perform any part of the Work. The associate undertakes to bear the incremental costs if any paid by TPWODL in such a case attributable to failure on the part of the associate. The Associate in such a case shall not be entitled to receive any further payments and any sums found payable to it may be adjusted by TPWODL against the amount recoverable from him on this ground. The same shall be without prejudice to other rights available to TPWODL under law against the associate.

Upon the termination of any of the contract due to occurrence of any circumstances provided in clauses stated above and constituting repeated breach or misconduct , TPWODL shall be entitled to bar the associates its agents , affiliates from undertaking any negotiation / tendering, bidding , participation activities concerning TPWODL for a period of two years from date of such termination. The same shall be without prejudice to other rights available to TPWODL.

22.2 Termination for Convenience of Associate

Associate at its convenience may request for termination of contract, clearly assigning the reason for such request. TPWODL has full right to accept, reject or partially accept such request. However, associate shall continue its supply as per contract till final approval is given to associates for such termination.

22.3 Termination for Convenience of TPWODL

TPWODL at its sole discretion may terminate the contract by giving 30 days prior notice in writing or through email to the Associate. TPWODL shall pay the Associate for all the supplies/ services rendered till the actual date of contract termination against submission of invoice by the Associate to that effect.

Doc. Title	GENERAL CONDITIONS OF CONTRACT FOR SUPPLY ORDERS	
Rev. No	0	Page 23 of 44

23.0 DISPUTE RESOLUTION & ARBITRATION

In case of any dispute or difference the parties shall endeavor to resolve the same through conciliatory and amicable measures within 15 Days failing which the matter may be referred by either party for resolution by the sole arbitrator to be appointed mutually by both the parties. The arbitral proceedings shall be conducted in accordance with Arbitration and Conciliation Act 1996 and the place of arbitration shall be Sambalpur. The language to be used at proceedings shall be English and the award of the arbitrator shall be final and binding on the parties. The parties shall bear their respective costs of arbitration. The associate shall continue to discharge its obligations towards due performance of the works as per the terms of the contract during the arbitration proceedings unless otherwise directed in writing by TPWODL or suspended by the arbitrator. Further, TPWODL shall continue making such payments as may be found due and payable to the associate for such works.

23.1 Governing Laws and Jurisdiction

The parties shall be subject to the jurisdiction of the courts of law in Sambalpur and any matter arising here from shall be subject to applicable law in force in India.

24.0 ATTRIBUTES OF GCC

24.1 Cancellation

The Company reserves the right to cancel, add, delete at its sole discretion, all or any terms of this GCC or any contract, order or terms agreed between the parties in pursuance without assigning any reasons and without any compensation to the Associates.

24.2 Severability

If any portion of this GCC is held to be void, invalid, or otherwise unenforceable, in whole or part, the remaining portions of this GCC shall remain in effect.

24.3 Order of Priority

In case of any discrepancies between the stipulations in General Conditions of the Contract (GCC) and Special Conditions of Contract (SCC), the GCC shall stand superseded by the SCC to the extent stipulated hereinabove while balance portion of respective clauses of GCC shall continue to be applicable.

25.0 ERRORS AND OMISSIONS

The Associate shall be responsible for all discrepancies, errors and omissions in the drawings, documents or other information submitted by him, irrespective of whether these have been approved, reviewed or otherwise accepted by the TPWODL or not. However any error in design/drawing arising out of any incorrect data/written information from TPWODL will not be considered as error and omissions on part of the Associate.

26.0 TRANSFER OF TITLES

The title of ownership and property to all equipment, materials, drawings & documents shall pass to the TPWODL on acceptance of material by store/site after Inspection.

However, such passing of title of ownership and property to the TPWODL shall not in any way absolve, dilute or diminish the responsibility and obligations of the Associate under this Contract including loss or damages and all risks, which shall vest with the Associate.

Doc. Title	GENERAL CONDITIONS OF CONTRACT FOR SUPPLY ORDERS	
Rev. No	0	Page 24 of 44

27.0 INSURANCE

The Contractor shall take out the Insurance Policies which shall cover all risks including the following, as applicable:-

- a) The value of the policy shall cover the total value of all the items till they are handed over to TPWODL.
- b) TPWODL shall be the principal holder of the policy. The Associate shall be the loss payee under the policy. Associate / Sub-contractor of the Associate shall not be holders or beneficiaries in the policy nor shall they be named in the policy. TPWODL reserves the exclusive right to assign the policy.
- c) While the payment of premium may be phased in agreement with the insurance company, at no time shall goods and services required to be provided by the associate shall remain uninsured in accordance with (a) above.
- d) A copy of the Insurance policy shall be made available to TPWODL prior to first dispatch lot of any Equipment and policy shall be kept alive and valid at all times up to the stage of final acceptance.
- e) TPWODL reserves the right to take out whatever policy that is deemed necessary by him if the associate fails to keep the said policy alive and valid at all times and/or causes lapses in payment of premium thereby jeopardizing the said policy. The cost of such policy(s) shall be recovered / deducted from the amount payable to the associate.
- f) The policy shall ensure that the TPWODL's decision regarding replacement of goods damaged, lost or rendered unusable shall be final.

In all cases, the associate shall lodge the claims with the underwriters and also settle the claims and shall also notify TPWODL of any filed claims. However, the associate shall proceed with the repairs and/or replacement of the equipment/components without waiting for the settlement of the claims. In case of seizure of materials by concerned authorities, the associate shall arrange prompt release against bond, security or cash as required. TPWODL, upon request by the associate, will extend all reasonable assistance to the associate in such a case.

All the insurance claims shall be processed and settled by the associate and the missing/damaged items shall be replaced/repared by them without any extra cost to TPWODL and without affecting the completion time.

28.0 SUGGESTIONS & FEEDBACK

We welcome all our Business Associates to write to us about their experience with TPWODL; be it our Company, our services or our people. Each and every concern, issue, query and suggestion from you will help us to become a better company to work with and shall help us develop a strong bonding of trust and a long term relationship with you.

You may send your feedback by filling up our Business Associate Feedback Form enclosed herewith as *Annexure-I*. You can also log on to our website www.tatapower.com to provide your feedback.

- Suggestions for us
- Feedback form
- Knowledge Sharing/ Experience with TPWODL

Doc. Title	GENERAL CONDITIONS OF CONTRACT FOR SUPPLY ORDERS	
Rev. No	0	Page 25 of 44

- Any issues with TPWODL.

Submission of feedback form is mandatory before the release of final payment to the BA.

29.0 CONTACT POINTS

In case Business Associate needs information with respect to payments or has any grievances, same may be lodged by log on to our website www.tatapower.com

30.0 LIST OF ANNEXURES

S. No.	Subject	Annexure
1.	Performa for Bid Security Bank Guarantee	A
2.	Performa for Performance Bank Guarantee (CP cum EP)	B
3.	Performa for No Demand Certificate by Associate	C
4.	Performa For Application For Issuance of Consolidated TDS Certificate	D
5.	Business Associate Feedback Form	E
6.	Acceptance Form For Participation In Reverse Auction Event	F
7.	Form for RTGS Payment	G
8.	Vendor Appraisal Form	H
9.	Manufacturer Authorization Form	I

Doc. Title	GENERAL CONDITIONS OF CONTRACT FOR SUPPLY ORDERS	
Rev. No	0	Page 26 of 44

ANNEXURE-A

PROFORMA FOR BID SECURITY BANK GUARANTEE

**TP Western Odisha Distribution Ltd
Burla**

WHEREAS, (Name of the Bidder) _____
(hereinafter called "the BIDDER") has submitted his bid dated _____ for the
(Name of Contract) _____ (hereinafter called "the BID").

KNOW ALL men by these presents we (Name of the
Bank) _____ of (Name of the
Country) _____ having our registered
office at _____ (hereinafter called "the BANK) are bound unto The
TP Western Odisha Distribution Ltd (TPWODL) in the sum of _____ for
which payment well and truly to be made to the TPWODL the Bank binds himself, his
successors and assigns by these presents.

SEALED with the Common Seal of the said Bank this _____ day of _____ 20_____.

The CONDITIONS of this obligation are:

- i) If the Bidder withdraws his Bid during the period of bid validity specified in the Proforma of Bid or
- ii) If the Bidder having been notified of the acceptance of his Bid by the TPWODL during the period of bid validity fails or refuses to furnish the Contract Performance Bank Guarantee, in accordance with the Instructions to Bidders.

We undertake to pay the TPWODL upto the above amount upon receipt of its first written demand, provided that in its demand the TPWODL will note that amount claimed by it is due to it owing to the occurrence of one or both conditions, specifying the occurred condition or conditions.

Doc. Title	GENERAL CONDITIONS OF CONTRACT FOR SUPPLY ORDERS	
Rev. No	0	Page 27 of 44

This Guarantee will remain in force upto and including the date (No of days as mentioned in tender enquiry) days after the closing date of submission of bids as stated in the Invitation to Bid or as extended by you at any time prior to this date, notice of which extension to the Bank being hereby waived, and any demand in respect thereof should reach the Bank not later than the above date.

DATE **SIGNATURE OF THE BANK**

WITNESS **SEAL**

(Signature, Name & Address) (At least 2 witnesses)

ANNEXURE- B

PROFORMA FOR PERFORMANCE BANK GUARANTEE (CP cum EP)

(On Rs.100/- Stamp Paper) Note:

- a) Format shall be followed in toto
- b) Claim period of one month must be kept up
- c) The guarantee to be accompanied by the covering letter from the bank confirming the signature to the guarantee

TP Western Odisha Distribution Ltd

Burla

CP cum EP BG No.....

Order/Contract No.....dated.....

1. You have entered into a Contract No _____ with M/s. _____ (hereinafter referred to as "the Vendor") for the supply cum erection / civil work of _____ (hereinafter referred to as "the said Equipment") for the price and on the terms and conditions contained in the said contract.
2. In accordance with the terms of the said contract, "the Vendor" agreed to furnish you with an irrevocable, unconditional and acceptable bank guarantee for 10% of the value of contract and to be valid till the end of Guarantee period plus one month towards "Contract cum Equipment performance". For this purpose you have agreed to accept the guarantee.
3. In consideration thereof, we, _____ hereby irrevocably and unconditionally guarantee to pay to you on demand but in any case before the end of five working days from the date of the claim and without demur and without reference to "the Vendor" such amount or amounts not exceeding the sum of Rs. _____ (Rupees _____ only) being _____% (_____ percent) of the total value of the contract on receipt of your intimating that "the

Doc. Title	GENERAL CONDITIONS OF CONTRACT FOR SUPPLY ORDERS	
Rev. No	0	Page 28 of 44

Vendor” has not fulfilled his contractual obligations. You shall be the sole judge for such non-fulfillment and “the Vendor” shall have no right to question such judgment.

4. You shall have the right to file / make your claim on us under the guarantee for a **further period of one month** from the date of expiry.
5. This guarantee shall not be revoked without express consent and shall not be affected by your granting time or any other indulgence to “the Vendor”, which shall include but not be limited to, postponement from time to time of the exercise the same in you or any right which you may have against “the Vendor” and to exercise the same in any covenant contained or implied in the said contract or any other course or remedy or security available to you, and our Bank shall not be released from its obligations under this guarantee by

GENERAL CONDITIONS OF CONTRACT

Doc. Title	GENERAL CONDITIONS OF CONTRACT FOR SUPPLY ORDERS	
Rev. No	0	Page 29 of 44

your exercising any of your rights with reference to matters aforesaid or any of them or by reasons of any other act or forbearance or other acts of omission or commission on your part or any other indulgence shown by you or by any other matter or thing whatsoever which under the law would, but for this provision have the effect of relieving our bank from its obligation under this guarantee.

6. We also agree that you shall be entitled at your option to enforce this guarantee against our bank as a principal debtor, in the first instance, notwithstanding any other security or guarantee that you may have in relation to "the Vendor's" liabilities in respect of the premises
7. This guarantee shall not be affected by any change in the constitution of our Bank or "the Vendor" or for any other reason whatsoever.
8. Any claim / extension under the guarantee can be lodge-able at outstation banks or at Sambalpur branch and claim will also be payable at Sambalpur Branch (to be confirmed by Sambalpur Branch by a letter to that effect in case BG is from the branch outside Sambalpur).
9. Notwithstanding anything herein contained, our liability under this guarantee is limited to Rs. _____ (Rupees _____) only and the guarantee will remain in force upto and including _____ (Date) and shall be extended from time to time for such period or period as may be desired by "the Vendor".
10. Unless a demand or claim under this guarantee is received by us in writing within one months from _____ (expiry date) i.e. on or before _____ (claim period end date), we shall be discharged from all liabilities under this guarantee thereafter.

Dated at _____ this _____ day of _____ 20__

Bank's rubber stamp

1. Banks full address

Designation of Signatory

2. Bank official number

Doc. Title	GENERAL CONDITIONS OF CONTRACT FOR SUPPLY ORDERS	
Rev. No	0	Page 30 of 44

ANNEXURE-C

PROFORMA FOR “NO DEMAND CERTIFICATE” BY ASSOCIATE

(On Company’s Letter head or with Company Seal)

(To be submitted by the Associate to TPWODL Accounts Department at the time of receipt of full and final payment)

(Certificate No. CCP/002)

Name of the Project Order/

Contract No.

Dated

Name of the Associate Scheme

No. / Job No.

We, M/s. _____ (Associate) do hereby acknowledge and confirm that we have received the full and final payment due and payable to us from TPWODL, in respect of our aforesaid Order No _____ dated _____ including amendments, if any, issued by TPWODL to our entire satisfaction and we further confirm that we have no claim whatsoever pending with TPWODL under the said contract / W.O.

Notwithstanding any protest recorded by us in any correspondence, documents, measurement books and / or final bills etc., we waive all our rights to lodge any claim or protest in future under this contract.

We are issuing this “NO DEMAND CERTIFICATE” in favour of TPWODL, with full knowledge and with our free consent without any undue influence, misrepresentation, coercion etc.

Place

Name

(Company Seal)

Doc. Title	GENERAL CONDITIONS OF CONTRACT FOR SUPPLY ORDERS	
Rev. No	0	Page 31 of 44

ANNEXURE-D

**PROFORMA FOR APPLICATION FOR ISSUANCE OF CONSOLIDATED TDS
CERTIFICATE**

To be printed on the letterhead

To,

The TP Western Odisha Distribution Ltd,

Burla

Sub: Application for issuance of Consolidated TDS Certificate for the FY _____

Dear Sir,

I / we hereby request / authorize you to issue me / us a consolidate TDS Certificate for the financial year _____ against tax deducted at source by you from my / our payments / bills during the said year from time to time under Chapter XVII – B of the Income Tax Act, 1961. For and on behalf of

Signature

Name

Address

Contact No. (Land Line)

(Mobile)

PAN #

Assessing authority

ATTACH THE COPY OF PAN CARD

Doc. Title	GENERAL CONDITIONS OF CONTRACT FOR SUPPLY ORDERS	
Rev. No	0	Page 32 of 44

ANNEXURE-E

BUSINESS ASSOCIATE FEEDBACK FORM

With an objective to improve our internal processes and systems, and serve you better, we solicit your valuable feedback & suggestions. It is estimated that it will take about 10 minutes to complete this survey. We assure you that your feedback shall be kept confidential. Please send the duly filled feedback form in the "TPWODL addressed - attached envelop"

You are associated with us as

- OEMs Service Contractor Material Suppliers Material & Manpower Supplier

You are associated with us for

- Less than 1 year More than 1 year but less than 3 years More than 3 years

Your office is located at

- Sambalpur Within 200 kms from Sambalpur More than 200 kms from Sambalpur

Your nearly turnover with TPWODL

- Less than 25 Lacs 25 Lacs to 1 Crore More than 1 Cr.

Additional Information

Your Name	
Your Designation	
Your Organization	
Contact Nos.	
Email	

We once again thank you for your participation in this survey. Please spare 10 minutes to give your feedback on following pages (Section A to E)

Doc. Title	GENERAL CONDITIONS OF CONTRACT FOR SUPPLY ORDERS	
Rev. No	0	Page 33 of 44

SECTION – A

(Please ✓ mark in the relevant box and give your remarks / suggestions / information for our improvement).

S. No.	Parameters	1	2	3	4	5	Remarks/ Suggestion
		Do Not Agree	Slightly in Agreement	In Fair Agreement	Mostly in Agreement	Fully Agree	
1	You receive all relevant queries / tenders from us in timely manner.						
2	We provide you enough lead time to respond to our queries / tenders.						
3	We provide you adequate support (drawings, documents, clarifications, briefing etc.) to enable you meet our requirements.						
4	All following elements of our contract / purchase order are rational :						
4.1	Scope of Work						
4.2	Delivery / Execution Schedule						
4.3	Payment Terms						
4.4	Liquidated Damages						
4.5	Performance Guarantee						
5	Our purchase orders / contracts are simple, specific & easy to understand						
6	TPWODL demonstrate willingness to be flexible in administration of Contract / Purchase Order						
7	We provide timely responses / clarifications to your queries						
8	TPWODL representative you interact / coordinate with is adequately empowered to support you in meeting contractual obligations						
9	TPWODL provide you all necessary infrastructure support for timely and quality completion of work (including AMC)						
10	TPWODL Engineer-in-Charge timely certifies the jobs executed/ material supplied						
11	TPWODL Engineer-in-Charge efficiently supervises the job execution for timely completion of job						
12	BIRD (Bill Inward Receipt Desk) initiative has improved payment disbursement process						

Doc. Title	GENERAL CONDITIONS OF CONTRACT FOR SUPPLY ORDERS	
Rev. No	0	Page 34 of 44

S. No.	Parameters	1	2	3	4	5	Remarks/ Suggestion
		Do Not Agree	Slightly in Agreement	In Fair Agreement	Mostly in Agreement	Fully Agree	
13	Our approach for Inspection and Quality Assurance effective to expedite project completion?						
14	TPWODL never defaults on contractual terms						
15	In TPWODL Contracts closure is done within set time limit						
16	Our material receiving procedures are well defined and efficiently deployed to reduce mutual inconvenience						
17	Bank Guarantees are released in time bound manner						
18	Our processes related to payment / account settlement are effective.						
19	You get payments on time						
20	TPWODL Employees follow Ethical behaviour						

GENERAL CONDITIONS OF CONTRACT

Doc. Title	GENERAL CONDITIONS OF CONTRACT FOR SUPPLY ORDERS		
Rev. No	0	Page 35 of 44	

SECTION – B

SECTION – B (Please rate the following parameters on a scale of 1 to 5, where 1 - Minimum; 5 - Maximum)

S. No.	Parameters	1	2	3	4	5	Remarks/ Suggestion
1	How do you rate courtesy/ empathy/ attitude level and warmth of TPWODL employees you interact with from following team?						
1.1	Project Engineering						
1.2	District / Zones						
1.3	Projects/HOG (TS &P)						
1.4	Inspection & Quality Assurance						
1.5	Stores						
1.6	Metering & Billing						
1.7	Accounts / Finance						
1.8	Administration						
1.9	IT & Automation						
2	How would you rate TPWODL in comparison to your other clients in terms of fairness of treatment and transparency with its Business Associates?						
3	How would you rate TPWODL in comparison to your other clients in terms of processes and systems to manage partnership with its Business Associates						
4	How would you rate TPWODL in comparison to your other clients in terms of building long term & mutually relationship with its Business Associates						

SECTION – C

Please ✓ mark in the relevant box and give your remarks / suggestions / information for our improvement.

S. No.	Parameters	Certainly No	Probably No	Certainly Yes	Probably Yes	Remarks/ Suggestion
1	Based on your experience with TPWODL, would you like to continue your relationship with TPWODL?					
2	If someone asks you about TPWODL, would you talk "positively" about					

Doc. Title	GENERAL CONDITIONS OF CONTRACT FOR SUPPLY ORDERS	
Rev. No	0	Page 36 of 44

	TPWODL?					
3	Would you refer TPWODL name to others in your community, fraternity and society as a professional & dynamic organization?					

SECTION - D

If we ask you to rate us on a scale of 1 to 10, how will you rate TPWODL, that truly represents your overall satisfaction with us (please tick appropriate box) -

1	2	3	4	5	6	7	8	9	10
---	---	---	---	---	---	---	---	---	----

SECTION - E

Please ✓ mark in the relevant box and give your remarks / suggestions / information for our improvement.

Please spare your thoughts for TPWODL's improvement in particular areas of weaknesses, particularly relating to some great practices, attitudes that you have seen elsewhere in Indian and International Organizations, which you recommend TPWODL to adopt. Please give your valuable salient recommendations.

Please spare your thoughts for TPWODL's improvement in particular areas of major concerns for you. We also welcome your suggestions to adopt any best practices, attitudes that you

Recommendation	<i>Please tick (✓) your top 5 expectations out of the following 10 points listed below -</i>	
(Please list down improvement you expect from TPWODL)	<i>Timely payment</i>	
1	<i>Flexibility in Contracts/PO</i>	
	<i>Clarity in PO,s & Contracts</i>	
2	<i>Timely response to quarries</i>	
	<i>Timely certification of works executed</i>	
3	<i>Clarity in Specs, drawings, other docs etc.</i>	
	<i>Adequate information provided on website for tender notification, parties qualified etc.</i>	
4	<i>Timely receipt of material at site for execution</i>	

Doc. Title	GENERAL CONDITIONS OF CONTRACT FOR SUPPLY ORDERS	
Rev. No	0	Page 37 of 44

	<i>Performance Guarantee/EMD released in time</i>	
5	<i>Inspection & quality assurance support for timely job completion</i>	

We thank you for your time and courtesy!!

ANNEXURE-F

ACCEPTANCE FORM FOR PARTICIPATION IN REVERSE AUCTION EVENT

(To be signed and stamped by the bidder prior to participation in the auction event)

In a bid to make our entire procurement process more fair and transparent, TPWODL intends to use the reverse auctions through SAP-SRM tool as an integral part of the entire tendering process. All the bidders who are found as technically qualified based on the tender requirements shall be eligible to participate in the reverse auction event.

The following terms and conditions are deemed as accepted by the bidder on participation in the bid event:

1. TPWODL shall provide the user id and password to the authorized representative of the bidder. (Authorization Letter in lieu of the same shall be submitted along with the signed and stamped Acceptance Form).
2. TPWODL will make every effort to make the bid process transparent. However, the award decision by TPWODL would be final and binding on the supplier.
3. The bidder agrees to non-disclosure of trade information regarding the purchase, identity of TPWODL, bid process, bid technology, bid documentation and bid details.
4. The bidder is advised to understand the auto bid process to safeguard themselves against any possibility of non-participation in the auction event.
5. In case of bidding through Internet medium, bidders are further advised to ensure availability of the entire infrastructure as required at their end to participate in the auction event. Inability to bid due to telephone line glitch, internet response issues, software or hardware hangs, power failure or any other reason shall not be the responsibility of TPWODL.
6. In case of intranet medium, TPWODL shall provide the infrastructure to bidders. Further, TPWODL has sole discretion to extend or restart the auction event in case of any glitches in infrastructure observed which has restricted the bidders to submit the bids to ensure fair & transparent competitive bidding. In case an auction event is restarted, the best bid as already available in the system shall become the start price for the new auction.
7. In case the bidder fails to participate in the auction event due any reason whatsoever, it shall be presumed that the bidder has no further discounts to offer and the initial bid as submitted by the bidder as a part of the tender shall be considered as the bidder's final no regret offer. Any offline price bids received from a bidder in lieu of non-participation in the auction event shall be out rightly rejected by TPWODL.
8. The bidder shall be prepared with competitive price quotes on the day of the bidding event.
9. The prices as quoted by the bidder during the auction event shall be inclusive of all the applicable taxes, duties and levies and shall be FOR at TPWODL site.
10. The prices submitted by a bidder during the auction event shall be binding on the bidder.
11. No requests for time extension of the auction event shall be considered by TPWODL.
12. The original price bids of the bidders shall be reduced on pro-rata basis against each line item based on the final all inclusive prices offered during conclusion of the auction event for arriving at Contract amount.

Signature & Seal of the Bidder

Doc. Title	GENERAL CONDITIONS OF CONTRACT FOR SUPPLY ORDERS	
Rev. No	16	Page 38 of 44

ANNEXURE-G

To,

DGM (Finance)
The TP Western Odisha Distribution Ltd
Burla

Sub: e-Payments through National Electronic Fund Transfer (NEFT) OR Real Time Gross Settlement System (RTGS)

Dear Sir,

We request and authorize you to affect e-payment through NEFT/RTGS to our Bank Account as per the details given below:-

Vendor Code :

Title of Account in the Bank :

Account Type :

(Please mention here whether account is Savings/Current/Cash Credit)

Bank Account Number :

--	--	--	--	--	--	--	--	--	--	--	--	--	--	--	--	--	--	--	--	--

Name & Address of Bank :

Bank Contact Person's Names :

Bank Tele Numbers with STD Code :

Bank Branch MICR Code :

--	--	--	--	--	--	--	--	--	--	--	--	--	--	--	--	--	--	--	--	--

(Please enclose a Xerox a copy of a cheque. This cheque should not be a payable at par cheque)

Bank Branch IFSC Code :

--	--	--	--	--	--	--	--	--	--	--	--	--	--	--	--	--	--	--	--	--

(You can obtain this from branch where you have your account)

Email Address of accounts person: :
(to send payment information)

Doc. Title	GENERAL CONDITIONS OF CONTRACT FOR SUPPLY ORDERS	
Rev. No	16	Page 39 of 44

Name of the Authorized Signatory: _____ :

Contact Person's Name:

Official Correspondence Address:

We confirm that we will bear the charges, if any, levied by our bank for the credit of NEFT/RTGS amounts in our account. Any change in above furnished information shall be informed to TPWODL well in time at our own. Further, we kept TPWODL indemnified for any loss incurred due to wrong furnishing of above information.

Thanking you,

For _____

(Authorised Signatory)

(Signature with Rubber Stamp)

Certification from Bank:

We confirm that we are enabled for receiving NEFT/RTGS credits and we further confirm that the account number (specify Bank a/c no.) of (Please mention here name of the account holder), the signature of the authorised signatory and the MICR and IFSC Code of our branch mentioned above are correct.

This also is certified that the above information is correct as per Bank record

(Manager's/ Officers Signature under Bank Stamp)

Doc. Title	GENERAL CONDITIONS OF CONTRACT FOR SUPPLY ORDERS	
Rev. No	16	Page 40 of 44

ANNEXURE-H
VENDOR APPRAISAL FORM

TO BE SUBMITTED BY VENDOR (To be filled as applicable)			
VENDOR:			
1.0	DETAILS OF THE FIRM		
	1.1	NAME (IN CAPITAL LETTERS)	:
	1.2	TYPE OF CONCERN (PROPRIETARY) Partnership, Pvt. Ltd., Public Ltd. etc.	:
	1.3	YEAR OF ESTABLISHMENT	:
	1.4	LOCATION OF OFFICE POSTAL ADDRESS TELEGRAPHIC ADDRESSES, TELEX NO. FAX NO.	:
	1.5	LOCATION OF MANUFACTURING UNITS	:
		i) UNITS 1	:
		ii) OTHER UNITS	:
2.0	PRODUCTS MANUFACTURED		
3.0	TURNOVER DURING THE LAST 3 YEARS (TO BE VERIFIED WITH THE LATEST PROFIT & LOSS STATEMENT).		
4.0	VALUE OF FIXED ASSETS		
5.0	NAME & ADDRESS OF THE BANKERS		
6.0	BANK GUARANTEE LIMIT		
7.0	CREDIT LIMIT		
8.0	TECHNICAL		
	8.1	NO. OF DESIGN ENGINEERS (INDICATE NO. OF YEARS EXPERIENCE IN RELATED FIELDS)	:
	8.2	NO. OF DRAUGHTS MEN	:
	8.3	COLLABORATION DETAILS (IF ANY)	:
		8.3.1 DATE OF COLLABORATION	:
		8.3.2 NAME OF COLLABORATOR	:
		8.3.3 RBI APPROVAL DETAILS	:
		8.3.4 EXPERIENCE LIST OF COLLABORATOR	:
		8.3.5 DURATION OF AGREEMENT	:
	8.4	AVAILABILITY OF STANDARDS / DESIGN PROCEDURES / COLLABORATOR'S /	:

Doc. Title	GENERAL CONDITIONS OF CONTRACT FOR SUPPLY ORDERS	
Rev. No	16	Page 41 of 44

		DOCUMENTS (CHECK WHETHER THESE ARE LATEST/CURRENT)	
	8.5	TECHNICAL SUPPORT, BACK-UP GUARANTEE, SUPERVISION, QUALITY CONTROL BY COLLABORATOR (WHEREVER ESSENTIAL). (THIS CLAUSE IS RELEVANT WHEN VENDOR'S EXPERIENCE IS INADEQUATE)	:
	8.6	QUALITY OF DRAWINGS	:
9.0	MANUFACTURE		
	9.1	SHOP SPACE, LAYOUT LIGHTING, VENTILATION, ETC.	:
	9.2	POWER (KVA)	:
		MAINS INSTALLED	:
		UTILIZED	:
		STANDBY POWER SOURCE	:
	9.3	MANUFACTURING FACILITIES (ATTACH LIST OF EQUIPMENT AS APPLICABLE)	:
		9.3.1 MATERIAL HANDLING	:
		9.3.2 MACHINING	:
		9.3.3 FABRICATION	:
		9.3.4 HEAT TREATMENT	:
		9.3.5 BALANCING FACILITY	:
		9.3.6 SURFACE TREATMENT PRIOR TO PAINTING/ COATING, POLISHING, PICKLING, PASSIVATION, PAINTING, ETC.	:
	9.4	SUPERVISORY STAFF	:
	9.5	ADEQUACY OF SKILLED LABOURS (MACHINISTS, WELDERS, ETC.)	:
	9.6	NO. OF SHIFTS	:
	9.7	TYPE OF MATERIAL HANDLED (SUCH AS CS, SS, ETC.)	:
	9.8	WORKMANSHIP	:
	9.9	MATERIAL IN STOCK AND VALUE	:
	9.10	TRANSPORT FACILITIES	:
	9.11	CARE IN HANDLING	:
10.0	INSPECTION / QC / QA / TESTING		
	10.1	NUMBER OF PERSONNEL (INDICATE NO. OF YEARS OF EXPERIENCE)	:
	10.2	INDEPENDENCE FROM PRODUCTION	:

Doc. Title	GENERAL CONDITIONS OF CONTRACT FOR SUPPLY ORDERS	
Rev. No	16	Page 42 of 44

	10.3	AVAILABILITY OF PROCEDURAL WRITE UP/QUALITY PLAN	:
	10.4	INCOMING MATERIAL CONTROL AND DOCUMENTATION	:
	10.5	RELIABILITY/REPUTATION OF SUPPLY SOURCES	:
	10.6	STAGE INSPECTION AND DOCUMENTATION	:
	10.7	SUB-ASSEMBLY & DOCUMENTATION	:
	10.8	FINAL INSPECTION AND DOCUMENTATION	:
	10.9	PREPARATION OF FINAL DOCUMENTATION PACKAGE	:
	10.10	TYPE TEST FACILITIES	:
	10.11	ACCEPTANCE TEST FACILITIES	:
	10.12	CALIBRATION OF INSTRUMENTS AND GAUGES (WITH TRACEABILITY TO NATIONAL STANDARDS) (ATTACH LIST)	:
	10.13	STATUTORY APPROVALS LIKE BIS, IBR, ETC.(AS APPLICABLE)	:
	10.14	SUB-VENDOR APPROVAL SYSTEM AND QUALITY CONTROL	:
	10.15	DETAILS OF TESTS CARRIED OUT AT INDEPENDENT RECOGNIZED LABORATORIES	:
		i) FURNISH LIST OF TESTS CARRIED OUT AND THE NAME OF THE LABORATORY WHERE THE TESTS WERE CONDUCTED	:
		ii) CHECK AVAILABILITY OF CERTIFICATES AND REVIEW THESE WHEREVER POSSIBLE	:
11.0		EXPERIENCE (INCLUDING CONSTRUCTION / ERECTION / COMMISSIONING) TO BE FURNISHED IN THE FORMAT INDICATED IN APPENDIX)	:
12.0		SALES, SERVICE AND SITE ORGANIZATIONAL DETAILS	:
13.0		CERTIFICATE FROM CUSTOMERS (ATTACH COPIES OF DOCUMENTS)	:
14.0		POWER SITUATION	:
15.0		LABOUR SITUATION	:
16.0 *		APPLICABILITY OF SC/ST RELAXATION (Y/N) IF YES, SUPPORTING DOCUMENTS TO BE ATTACHED	
17.0		ORGANIZATIONAL DETAILS 1. PF NO 2. ESI NO 3. INSURANCE FOR WORK MAN COMPENSATION ACT NO 4. ELECTRICAL CONTRACT LIC NO 5. ITCC / PAN NO 6. SALES TAX NO 7. WC TAX REG. NO	:
18.0		DOCUMENTS TO BE ENCLOSED:	

Doc. Title	GENERAL CONDITIONS OF CONTRACT FOR SUPPLY ORDERS	
Rev. No	16	Page 43 of 44

	<ol style="list-style-type: none"> 1. FACTORY LICENSE 2. ANNUAL REPORT FOR LAST THREE YEARS 3. TYPE TEST REPORT FOR THE ITEM 4. PAST EXPERIENCE REPORTS 5. ISO CERTIFICATE –QMS, EMS, OHAS, SA 6. REGISTRATION OF SALES TAX 7. COPY OF TIN NO. 8. COPY OF SERVICE TAX NO. 9. REGISTRATION OF CENTRAL EXCISE 10. COPY OF INCOME TAX CLEARANCE. 11. COPY OF PF REGISTRATION 12. COPY OF ESI REGISTRATION 13. COPY OF INSURANCE FOR WORK MAN COMPENSATION ACT NO 14. COPY OF ELECTRICAL CONTRACT LIC NO 15. COPY OF PAN NO 16. COPY OF WC TAX REGISTRATION 17. DOCUMENTS IN SUPPORT OF SC/ST RELAXATION AT S.NO.16.0 18. GSTN CERTIFICATE 	
--	--	--

* **Classification of BA s under SC/ST shall be governed under following guidelines:**

- **Proprietorship/ Single Ownership Firm:** Proprietor of the firm should be from SC/ST community. Governing document shall be Proprietorship Deed.
- **Partnership Firm:** Only such firms shall qualify which have SC/ST partners holding equal to or more than 50% of the total ownership pattern of the firm. Governing document shall be Partnership Deed.
- **Private Limited Company:** Only such firms shall qualify which have SC/ST directors holding equal to or more than 50% of the total ownership pattern of the firm. Governing document shall be Memorandum of Understanding (MoU) and/or Article of Association (AoA).

NOTE: Certification from SC/ST Commission shall be required for deciding upon SC/ST status of a person.

Doc. Title	GENERAL CONDITIONS OF CONTRACT FOR SUPPLY ORDERS	
Rev. No	16	Page 44 of 44

ANNEXURE-I

MANUFACTURER AUTHORIZATION FORM

(To be submitted on OEM's Letter Head)

Date:

Tender Enquiry No.:

To,
 Chief (Procurement & Stores)
 The TP Western Odisha Distribution Ltd,
 Burla

Sir,

WHEREAS M/s. [name of OEM], who are official manufacturers of having factories at [address of OEM] do hereby authorize M/s [name of bidder] to submit a Bid in relation to the Invitation for Bids indicated above, the purpose of which is to provide the following Goods, manufactured by us

.....and to subsequently negotiate and sign the Contract.

We hereby extend our full guarantee and warranty in accordance with the Special Conditions of Contract or as mentioned elsewhere in the Tender Document, with respect to the Goods offered by the above firm in reply to this Invitation for Bids.

We hereby confirm that in case, the channel partner fails to provide the necessary services as per the Tender Document referred above, M/s [name of OEM] shall provide standard warranty on the materials supplied against the contract. The warranty period and inclusion / exclusion of parts in the warranty shall remain same as defined in the contract issued to their channel partner against this tender enquiry.

Yours Sincerely,

For

Authorized Signatory

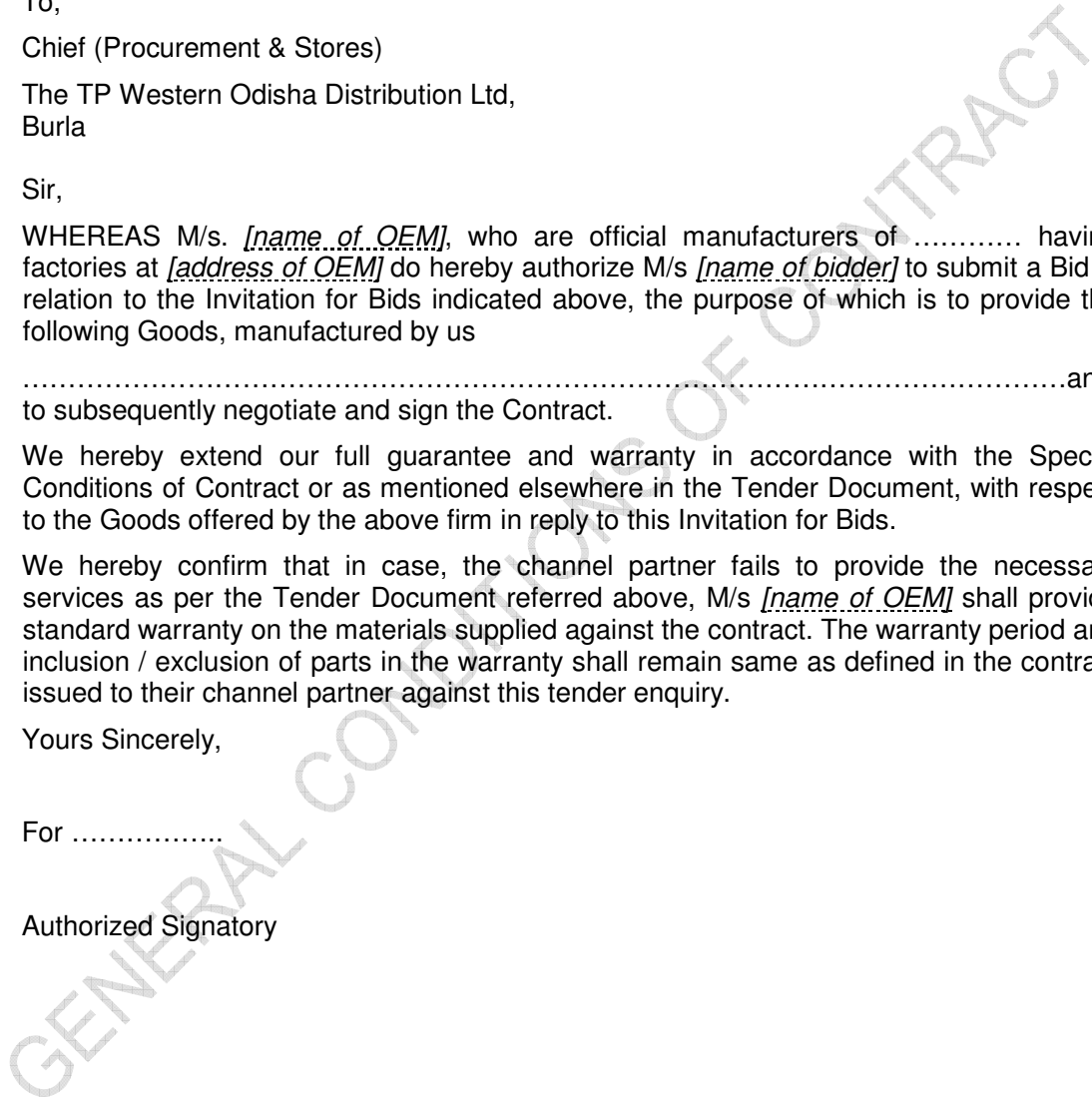

**For Reference- User Manual e-Bidding &
Auction (Ariba)**

CONFIDENTIAL



**SUPPLIER MANUAL ANSWERING
TO
E-BIDDING**

	Version 1.2
Company Confidential	DEC - 2020

INDEX

1 ACCESSING ARIBA SOURCING	3
2 VENDOR SCREEN.....	4
<i>2.1.1 Review and Approve “Prerequisites”</i>	<i>5</i>
<i>2.1.2 Select Items or Lots</i>	<i>6</i>
<i>2.1.3 Entering Your Prebid</i>	<i>6</i>
<i>2.1.4.1 How to submit a price.....</i>	<i>9</i>
3 COMMUNICATING WITH TATA POWER BUYER DURING E-BIDDING.....	7
4 ARIBA TRAINING AND ARIBA SUPPORT	8
5 SUPPLIER FREQUENTLY ASKED QUESTION	11

1- Accessing Ariba Sourcing

Step 1: You will get an invitation to your email from Ariba System. Keep this email, it contains your login Information and a direct link to Ariba.

Step 2: Click "Click Here" to access the Ariba Web Site.



Step 3: Supplier has to click on "Continue"

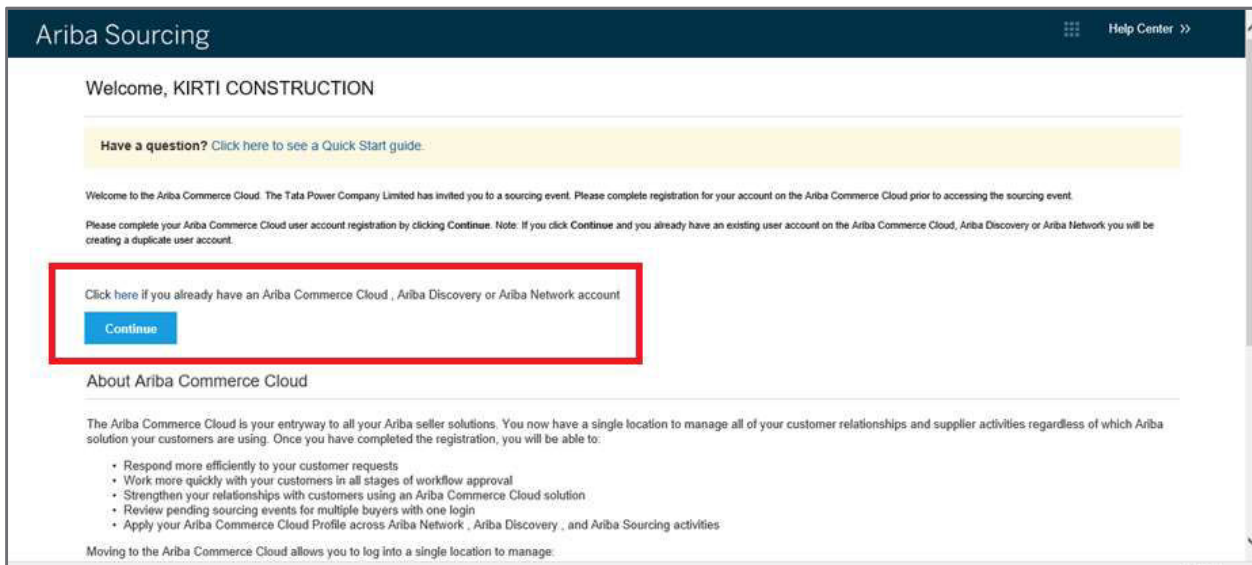

Step 4: The registration process only takes a few moments, with a simple one-page registration Define your password and secret question. Click "OK"

Company Name: KIRTI CONSTRUCTION

Country: India [IND]

Address: Yashodeep E3- 08
Sector 22 Koperkharne Navi Mumbai
400709

City: mumbai

State: maharashtra

Postal Code: 400709

Product and Service Categories: Enter Product and Service Categories [Add](#) -or- Browse

Ship-to or Service Locations: Enter Ship-to or Service Location [Add](#) -or- Browse

Tax ID: Optional Enter your Company Tax ID number.

DUNS Number: Optional Enter the nine-digit number issued by Dun & Bradstreet.

Supplier has to fill the form

Step 5: If it's the first time you are invited to use UPM Ariba, you'll need to accept the "Participant Terms". Select "I accept the terms of this agreement". Click "Submit".

The screenshot shows a registration form with the following elements:

- A password field with a masked input (*****).
- A "Secret Question" dropdown menu with the text "In what city was your mother born?". A note states: "The answer to your secret question must be atleast 5 characters."
- Two more masked input fields (*****).
- A "Language" dropdown menu set to "English". A note states: "The language used when Ariba sends you configurable notifications. This is different than your web b..."
- A paragraph of text explaining the company profile and data consent.
- A checkbox labeled "I have read and agree to the Terms of Use and the Ariba Privacy Statement", which is checked and highlighted with a red box.
- "Submit" and "Cancel" buttons at the bottom right.

2 Vendor Screen - Submitting Your Answers / Proposal

2.1.1 If vendor goes through mail invitation then directly Screen 3.1.1 will appear, but if If you have used Ariba before and have already accessed an event for the buyer-specific account with your current log in ID, click the **Login** button to continue. Log in with your Ariba username and password in order to participate in the event OR you have to follow the following steps.

Step 1 - Log on supplier.ariba.com

Step 2 - Put your USER ID and Password in following screen

The screenshot shows the SAP Ariba Supplier Login page. At the top, it says "SAP Ariba Proposals Powered by Ariba Sourcing" and includes a "Help Center" link. The main heading is "Supplier Login". Below this are two input fields for "User Name" and "Password", followed by a blue "Login" button. There is a link for "Forgot Username or Password" and a "Need help? See Quick Start" link at the bottom. On the right side, there is a laptop displaying a dashboard with various charts and data.

Step 3 - Go to "Ariba Proposals & Questionnaire".

The screenshot shows the Ariba Sourcing homepage. A blue oval highlights the 'Ariba Proposals and Questionnaire' menu item in the top navigation bar, with an arrow pointing to the text: "Goto 'Ariba Proposals & Questionnaire' after logging in at supplier.ariba.com". Another blue oval highlights the 'Events' table, with an arrow pointing to the text: "Events (Tender enquiries) in which Bidder has participated shall be visible. Click and enter into any specific event".

Title	ID	End Time	Event Type
▼ Status: Open (2)			
Maintenance of HT and LT Networks for Tata Power Distribution at Odisha (TPC-ENGG-ENQ-016-20-21)	Doc2416130949	6/4/2020 4:55 PM	RFP
Tender Documents-Meter Reading Cum Spot billing and Bill Distribution(TPC-ENGG-ENQ-015-20-21)	Doc2420255101	6/4/2020 3:00 PM	RFP

The screenshot shows the 'Event Details' page for Doc2420255101 - Tender Documents-Meter Reading Cum Spot bill... The page includes a 'Checklist' on the left with steps: 1. Review Event Details, 2. Review and Accept Prerequisites, 3. Submit Response. A blue oval highlights the 'Review Prerequisites' button, with an arrow pointing to the text: "Click on 'Review Prerequisites'". Below the button, the 'Tender Documents' section is visible, showing an introduction to the tender documents.

Review Prerequisites

Review the terms of the prerequisites before you can view event content or participate in the event.

Tender Documents

1.1 Introduction

1.1.1 Introduction

As per the Notice Inviting Tender dated 12th May 2020, Bidders are to download Tender from Tata Power website (Tenders section). Same Tender documents are attached in this E-tender enquiry for reference purpose.

As mentioned in the Procedure for participating in tender (which is enclosed with the tender documents), this e-Tender enquiry is being issued to the bidders who have purchased the tender documents following instructions therein.

All future/further communications wrt the subject tender and Bid submission shall be through this e-Enquiry only. Following is to be noted,

Next Section: Techno Commercial Bid

Tata Power - Ariba Spend Manag... X +

s1.ariba.com/Sourcing/Main/aw7a...

Checklist

1. Review Event Details
2. Review and Accept Prerequisites
3. Submit Response

Prerequisites must be completed prior to participation in the event.

In consideration of the opportunity to participate in on-line events ('On-Line Events') held and conducted by the company sponsoring this On-Line Event ('Sponsor') on the web site (this 'Site') hosted by Ariba, Inc. ('Site Owner'), your company ('Participant' or 'You') agrees to the following terms and conditions ('Bidder Agreement');

1. **Bids.** If you are invited to participate in the On-Line Event, Sponsor reserves the right to amend, modify or withdraw this On-Line Event. Sponsor reserves the right to accept or reject all or part of your proposal. Submission of a bid does not create a contract or any expectation by Participant of a future business relationship. Rather, by submitting a bid, you are making a firm offer which Sponsor may accept to form a contract, subject to section 2 below. Sponsor is not liable for any costs incurred by Participant in the preparation, presentation, or any other aspect of Participant's bid.
2. **Price Quotes.** Except to the extent Sponsor allows a non-binding bid, all Bids which Participant submits through the On-Line Events are legally valid quotations without qualification, except for data entry errors.
3. **Procedures and Rules.** Participant further agrees to be bound by the procedures and rules established by the Site and Sponsor.
4. **Confidentiality.** Participant shall keep all user names and passwords, the On-Line Event content, other confidential materials provided by the Site and/or Sponsor, and all bids provided by You or another participating organization in confidence and shall not disclose the foregoing to any third party.
5. **Bids through Site only.** Participant agrees to submit bids only through the on-line bidding mechanism supplied by the Site and not to submit bids via any other mechanism including, but not limited to, post, courier, fax, E-mail, or orally unless specifically requested by Sponsor.
6. **Ethical Conduct.** All parties will prohibit unethical behavior and are expected to notify the Site Owner by contacting the appropriate project team if they witness practices that are counter-productive to the fair operation of the On-Line Event. If Participant experiences any difficulties during a live On-Line Event, Participant must notify Site Owner immediately.
7. **Survival.** The terms and conditions of this Bidder Agreement shall survive completion of the On-Line Event.

BA v1.1 19Aug05

I accept the terms of this agreement.

I do not accept the terms of this agreement.

Accept the Terms of Agreement and Submit

Tata Power - Ariba Spend Manag... X +

s1.ariba.com/Sourcing/Main/aw7a...

Console Doc2420255101 - Tender Documents-Meter Reading Cum Spot bill... 8 days 03:33:47

Event Messages
Response History
Response Team

Checklist

1. Review Event Details
2. Review and Accept Prerequisites
3. Submit Response

Event Contents

- All Content
- 1 Tender Documents
- 2 Techno Commercial Bid
- 3 Price Bid

All Content

Name 1
2.1 Please attach the Techno-Commercial bid
2.2 Please attach your techno commercial offer (Extra File)
3 Price Bid
3.1 Bidder to specify the prices either in terms of percentage (%) or Value where the options are available for both percentage (%) , please Specify Zero (0) in the amount field and vice-versa.
3.2 Bidders to download editable copy of Price bid format (Which...), fill in the same with, and re-attach the same after filling in prices as their Price Bid. No Alterations/changes shall be made by the bidders in this... Requested.

(*) indicates a required field

Submit Entire Response Update Totals Page Excel Import

Devidra Sharma (desharma@gmail.com) last visited 26 May 2020 10:55:18 PM. Horizons Cybersoft Ltd AN01523824134 © 1996-2019 Ariba, Inc. All rights reserved. SAP Ariba Privacy Statement Security Disclosure Terms of Use

Technical Bid to be attached in Tab 2.1 and 2.2. Attach file link is towards extreme right, and is shown in next slide

Price Bid to be attached in Tab 3.2. Attach file link is towards extreme right, and is shown in next slide

These are "Attach File" links for Tab 2.1 and 2.2 where Technical bid is to be attached. Pls attach files in BOTH these tabs otherwise it will show error on submission.

Terms of percentage (%) or Value where the options are available for both. In case price is specified in 0 in the amount field and vice-versa.

This is "Attach File" link for Tab 3.2 (Price Bid).

Click On "Submit Entire Response" AFTER Attaching technical and Price bids as above.

Note: In case of multiple files, all files can be kept in one folder and folder can be converted to zip file for attaching

3 Communicating with Tata Power Buyer during e- bidding

Step 1: Click "Compose Message".

Step 2: Compose Your Message and click "Send".

back to The Tata Power Company Limited-TEST Dashboard Desktop File Sync Notifications

Compose New Message

From: shingare.manufacturers (Ravi Shingare)

To: Project Team

Subject: Dec681345837 -sourcing project 001

Attachments: attach a file

Dear Sir,

Can we submit the price ??

Regards

ABC

[Participating in a RFI or RFP on Ariba Network - https://www.youtube.com/watch?v=9_XXUaVyi7o](https://www.youtube.com/watch?v=9_XXUaVyi7o)

Here are the steps that Suppliers can follow for raising a ticket or requesting a call back from Support team. They can do so without logging in – pls follow the brief instructions given below.

1. Go to login page>Choose “Support” on the bottom right corner

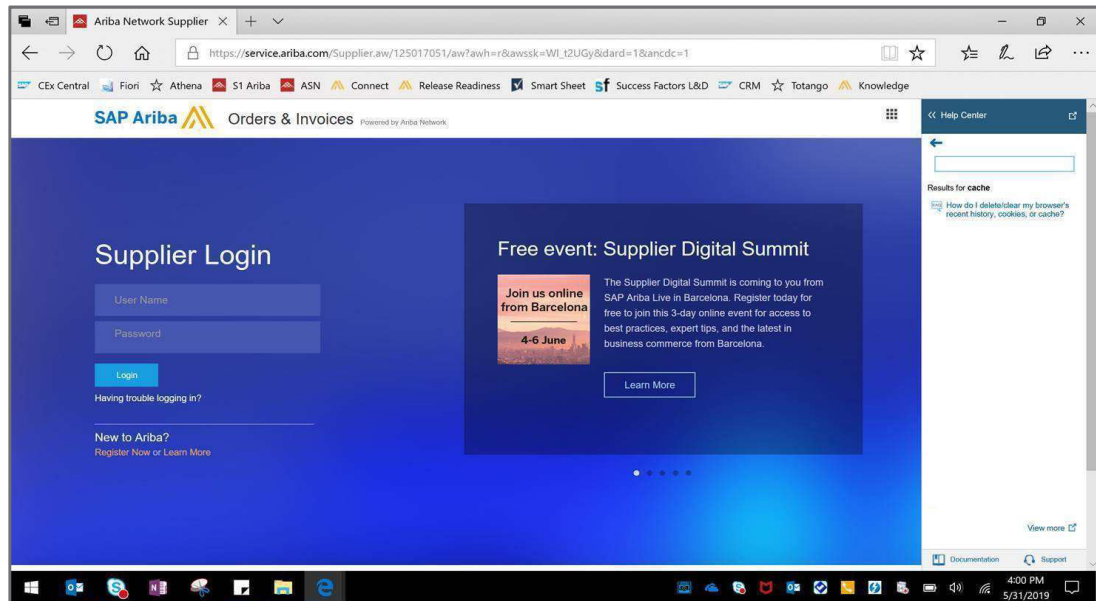

2. Add query and press “Start” – After that, following screen will pop up where you can choose either Get Help by Email or Get Help by Phone.

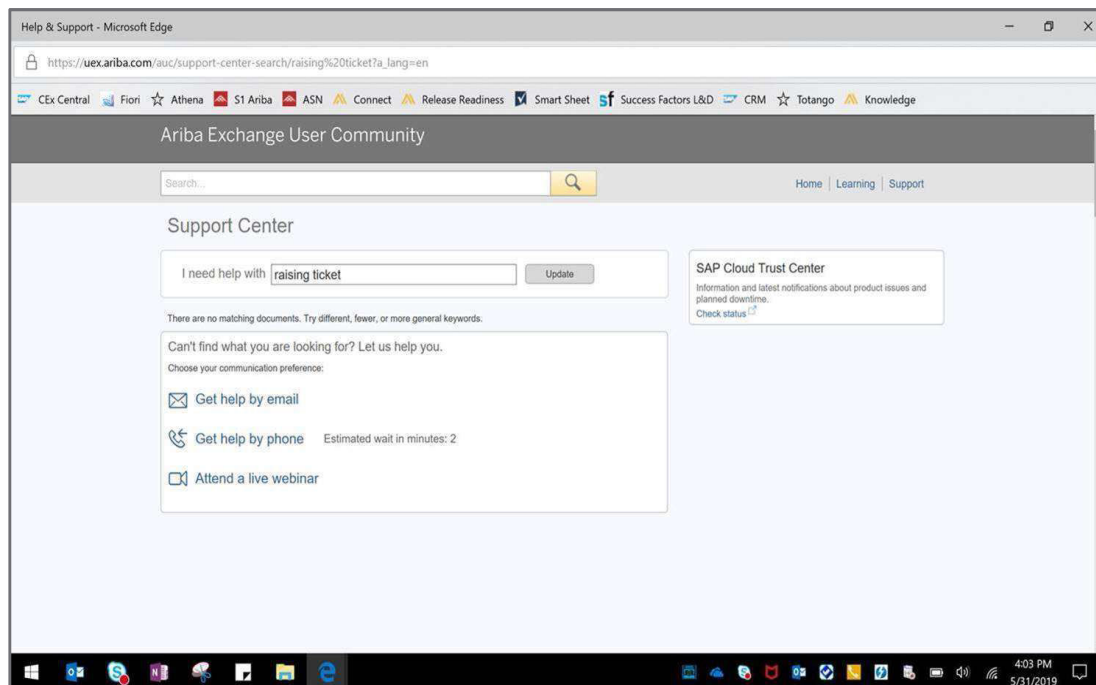

Click **Add Ship-to or Service Locations** to select one or more sales territories from a list. You can add, refine, or remove ship-to or service locations any time after the registration process.

Additional Information: - D-U-N-S is a registered trademark of Dun & Bradstreet or its subsidiaries in the United States and other countries.

What is the difference between the Email and Username fields in my profile?

Answer: - The Email field represents the email address where you wish to receive email notifications. The Username field is the identifier that you use to access your account. The Username field must be in email format, but you do not have to use a valid email address.

Note: Leave the **This is my username** box checked if you want your email address to be the same as your username.

How do I participate in my buyer's event using an email invitation?

Answer: - Use the **Click here** link in the email notification to access the sourcing event.

While buyers might customize the email content you receive, all email invitations contain a link to access the event.

Depending on your previous experience with Ariba solutions, do one of the following to access the event after you click the link:

- If you are new user, click **Continue** on the welcome page. You continue to register an Ariba account to link with your buyer and participate in the event.
- If you have used Ariba before and have already accessed an event for the buyer-specific account with your current log in ID, click the **Login** button to continue. Log in with your Ariba username and password in order to participate in the event.
- If you already have an existing Ariba Network, Ariba Discovery, or Ariba Sourcing supplier account, but you have not accessed any events for the inviting buyer's site, use the **Click here if you already have an Ariba Commerce Cloud, Ariba Discovery or Ariba Network account** link. After clicking the link, log in with your existing account to move your information to your buyer's site.

Additional Information:- Registering an Ariba account provides you with a consolidated view of all your customer relationships. With this one profile, you can view business opportunities, participate in sourcing events, participate in contract negotiations, and manage orders, catalogs, and invoices.

Why doesn't the link in the email invitation to participate in a sourcing event work?

Answer:-If you cannot click the link, or the link does not open the log in page, highlight and copy the Uniform Resource Locator (URL), and then paste the URL into your web browser.

Can my company have multiple accounts?

Answer:-Your Company can have multiple Ariba accounts, depending on your business needs. For example, if your company has several locations around the world, you might want a separate account for each region.

Most companies choose to have one account with multiple customer relationships, which provides a centralized location to maintain their company profile information and all of their customer relationships.

How do I complete registration if my username already exists?

Answer: - This message means that you already have an Ariba Network, Ariba Discovery, or Ariba Sourcing supplier account registered under username you entered. You can either register a new account by creating a new username, or access one of the following sites to request a password reset for the registered username:

- [Ariba Network](#) (This login page is used for all Ariba Network, Ariba Sourcing, or Ariba Contracts suppliers).
- [Ariba Discovery login page](#)

To reset your password, click the **Having trouble logging in?** Link on the Login page.

Nothing happens when I click Forgot Username and enter my email address

Issue: - Nothing happens when I click the **Forgot Username** link and enter my email address.

Cause: - After you submit your request to retrieve your username, the Ariba Network sends an email notification with usernames that match the email address you submitted.

Some possible reasons why you may not receive this username retrieval email notification:

- The email address on your account does not match the email address you entered when submitting the request.
- Your buyer-specific account was deactivated before you could move it to the Ariba Commerce Cloud. Generally, that means you probably have not participated in an event with that buyer for a while.

Solution: -

- To ensure you receive this email notification:
- Make sure you type the email address configured within your account.

If your buyer-specific account has been deactivated, contact your buyer to determine how to proceed.

Where is my password reset email?

Answer: - After you submit your request for a password reset, Ariba sends instructions to the email address associated with your account. If you didn't receive a password reset email, check the following scenarios to troubleshoot.

The username you entered is in the wrong format, or it isn't associated with the email address you are checking.

- Keep in mind, your username is in the format of a full email address, but it can be associated with any email address you entered previously.
- Your username is also case-sensitive.
- To confirm that you are using the correct username and format, return to the Ariba login page, and click the **Having trouble logging in?** link (**Forgot Username** if you're working in Ariba Discovery).
 - Choose **I forgot my username**, and click **Continue**.
 - Enter the email address associated with your account, and click **Submit**.

- You will receive an email that lists the exact format of the username associated with the email you entered.

You entered the correct username, but you still didn't receive the password reset email notification.

- This can occur if the configured email address is different from the account you are checking.
- You might have multiple accounts for your company, so make sure you are attempting to access the correct account.

Your email configuration or company's security settings might also prevent you from receiving the password reset email. To find out, check your junk mail folder or email filter settings to verify that automated emails from Ariba are not blocked from your email account.

 **Why do I get this message on the SAP Ariba Login page: "The username and password pair you entered was not found"?**

Answer: - You entered an incorrect **Username** or **Password**. You might receive this message if you entered a previous **Username** or **Password**. Remember that your **Username** has the format of an email address, and both the **Username** and **Password** are case sensitive.

Click the **Having trouble logging in?** Link on the Login page if you don't remember your log in information.